

RITMO

GRZEJNIKI
DEKORACYJNE



VASCOGROUP



jest kompleksowym dostawcą systemów ogrzewania i wentylacji działającym na rynku europejskim, ale także na odległych rynkach eksportowych takich jak Japonia, USA, Chiny i Nowa Zelandia. Marki należące do Vasco Group to Vasco, Brugman i Superia.

Vasco to wiodący producent grzejników dekoracyjnych, systemów wentylacyjnych, ogrzewania podłogowego oraz klimakonwektorów, a także lider w sprzedaży grzejników łazienkowych. Brugman i Superia są symbolami jakości w branży grzejników panelowych i należą do ścisłej czołówki w swoim segmencie. Vasco Group proponuje rozwiązania zapewniające komfort cieplny pomieszczeń, bazując na indywidualnych potrzebach klienta końcowego. Za sprawą poszukiwań materiałów alternatywnych, innowacyjnego designu i unowocześnionych procesów produkcji, firma Vasco zdobyła już wiele międzynarodowych nagród za design.

Główna siedziba firmy Vasco Group usytuowana jest w miejscowości Dilsen w Belgii. Zakłady produkcyjne znajdują się w Dilsen (Belgia), Tubbergen (Holandia) i Legnicy (Polska). Firma Vasco Group zatrudnia około 600 pracowników i stanowi część szwajcarskiej Grupy Arbonia.

ARBONIA 
www.arbonia.com



RITMO

KOMFORT OGRZEWANIA W STYLU RETRO

Ponadczasowa forma grzejnika kolumnowego

Ritmo to dla wielbicieli designu wyjątkowa zaleta.

Projektanci firmy Vasco wiedzą, że dekoracyjny

design i komfort ogrzewania można zamknąć

w pięknym, klasycznym kształcie.

Grzejniki dekoracyjne w stylu retro gwarantują

optymalny klimat Twojego wnętrza.

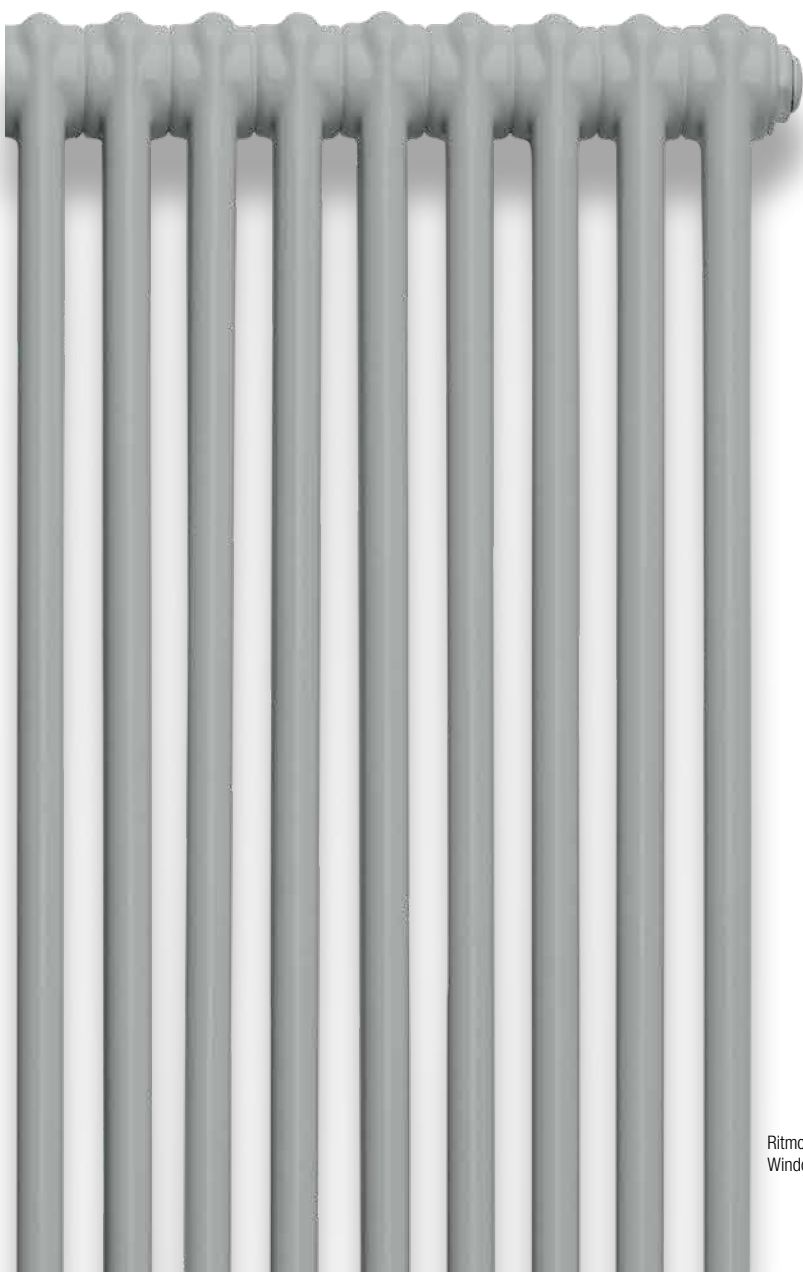

Ritmo pionowy
Window Grey RAL 7040



VASCO



RITMO PIONOWY

OD KLASYCZNYCH
KAMIENIC
DO
NOWOCZESNYCH
LOFTÓW

Wysokie, pionowe grzejniki kolumnowe idealnie nadają się do dużych i otwartych pomieszczeń. Od klasycznych kamienic do nowoczesnych loftów o przemysłowym charakterze: wysoki grzejnik kolumnowy w stylu retro. Ten grzejnik firmy Vasco osiąga także bardzo dobre parametry w połączeniu z systemami niskotemperaturowymi, na przykład z pompami ciepła. Grzejnik kolumnowy Ritmo w najdrobniejszym szczególe został zaprojektowany do oszczędnego i zrównoważonego zużycia energii. Wyposażono go w inteligentne systemy podłączenia i mocowania oraz innowacyjne rozwiązania technologiczne.



RITMO V-2K/65 (2-KOLUMNOWY)



RITMO V-3K/105 (3-KOLUMNOWY)



RITMO V-4K/145 (4-KOLUMNOWY)

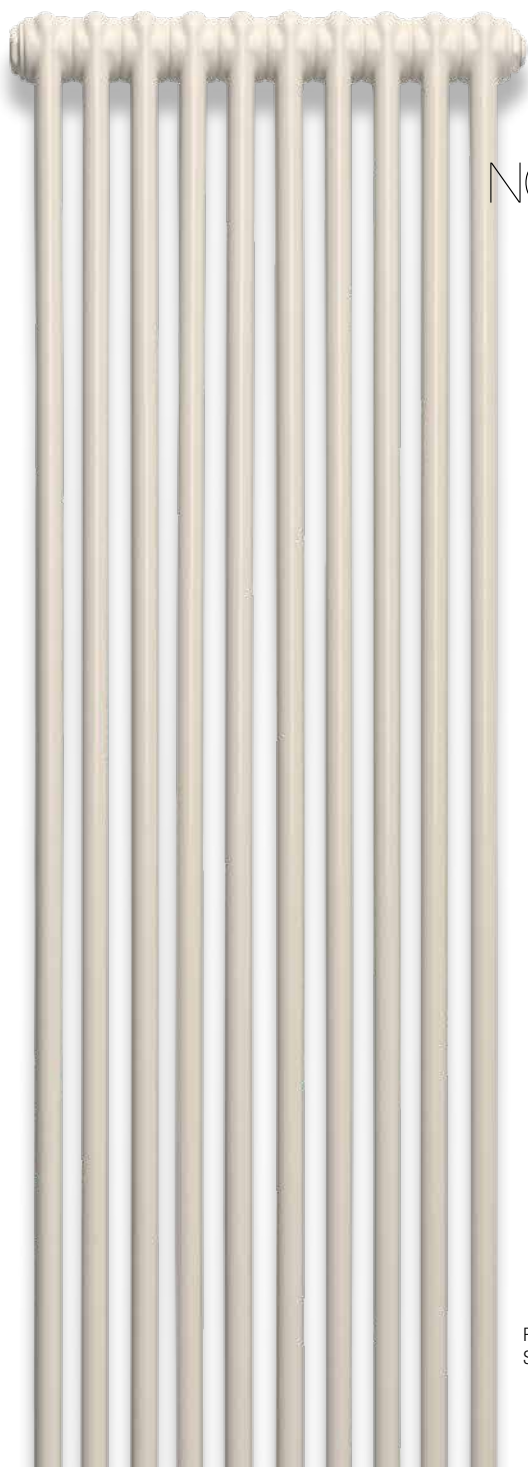

Ritmo pionowy
Sand N503

 **VASCO**

PIONOWY (V-2K/65, V-3K/105, V-4K/145)

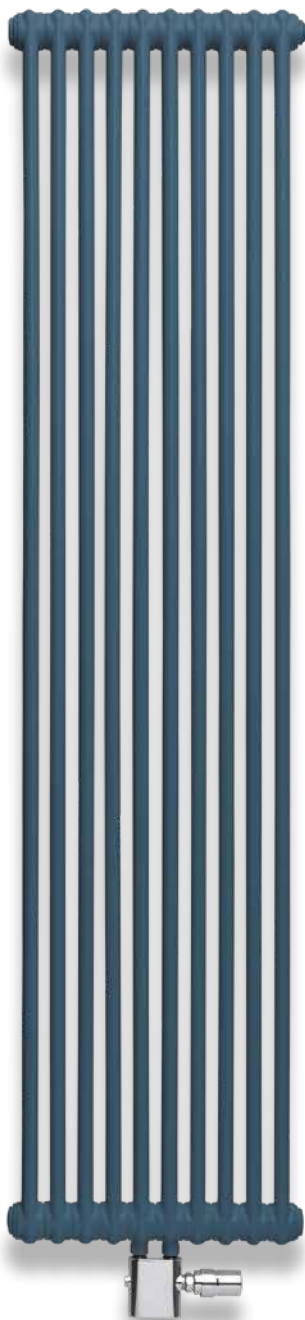

Ritmo pionowy Mid Blue RAL 9802

TYPY

- 2 / 3 / 4 kolumny
- Głębokość: 65 / 105 / 145 mm
- Wysokość: od 1500 do 2200 mm
- Długość: od 270 do 720 mm

RURKI

- Pionowe, $\phi 25$ mm

KOLORY

- Kolor standardowy biały RAL 9016
- Pozostałe kolory wg palety na str. 23

PODŁĄCZENIE

- Podłączenie dolne środkowe 1/2" GW. Rozstaw przyłączy 50 mm
- Punkty zasilania i powrotu dowolne – zależą od zastosowanego zaworu

DANE TECHNICZNE

- Okrągłe rury stalowe w układzie 2, 3, 4 kolumn
- Powłoka ATL, farba proszkowa
- Standardowe ciśnienie robocze: 10 bar
- Maksymalna temperatura robocza: 110°C

ZAWIESIA

- Zawiesia ścienne w kolorze grzejnika dostarczane w komplecie z grzejnikiem. Opis zestawów zawiesi ściennych oraz wykaz opcjonalnych konsoli podłogowych na str. 19 – 20

PRZYŁĄCZA

Odpowietrznik w punkcie 3 lub 6

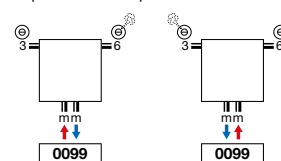

PORĘCZ NA RĘCZNIKI; CHROM



Nr kat. 118326500000099
Cena netto PLN: 602

ZAWÓR Z OSŁONKĄ PROSTĄ W KOLORZE BIAŁYM, CZARNYM LUB CHROM
LUB W KOLORZE GRZEJNIKA (11820010000xxxx)



Nr kat. 118200100009005
Cena netto PLN: 771



Nr kat. 118200100009016
Cena netto PLN: 672



Nr kat. 118200100000099
Cena netto PLN: 771



Nr kat. 11911630102
Cena netto PLN: 229



Nr kat. 11911631102
Cena netto PLN: 303



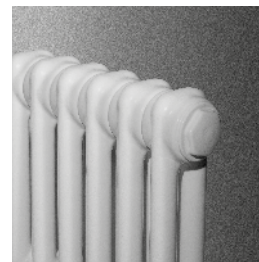
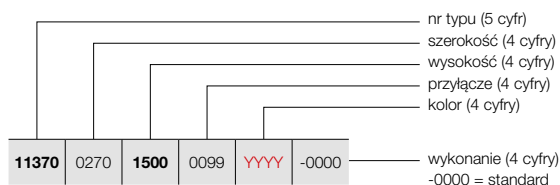

RITMO V-2K/65
(2-KOLUMNOWY)

Wykaz zawiesi i konsol na str. 19 – 20

GRUPA PRODUKTÓW: KOLUMNOWE

| KOD PRODUKTU NA ZAMÓWIENIE RITMO PIONOWY | DANE TECHNICZNE | | | | | | | | KOLOR STANDARD BIAŁY RAL 9016 | KOLORY |
|--|-----------------|----------------------|---------------------|-------------------------|-------------------------|----------------|--------------|----------------|----------------------------------|-------------------|
| | Liczba rurek | Szerokość L mm | Wysokość H mm | 75/65/20 Wat φ50K | 55/45/20 Wat φ30K | Wykładnik n | Ciężar kg | Pojemność l | Cena netto PLN | Cena netto PLN |
| V-2K/65 : 11370 | | | | | | | | | | |
| 11370 0270 1500 0099 YYY -0000 | 6 | 270 | 1500 | 654 | 333 | 1,32 | 11,58 | 7,92 | 1 450 | 1 668 |
| | 6 | 270 | 1800 | 780 | 397 | 1,32 | 13,74 | 9,36 | 1 528 | 1 757 |
| | 6 | 270 | 2000 | 864 | 440 | 1,32 | 15,18 | 10,32 | 1 620 | 1 863 |
| | 6 | 270 | 2200 | 948 | 483 | 1,32 | 16,68 | 11,28 | 2 120 | 2 438 |
| 11370 0360 1500 0099 YYY -0000 | 8 | 360 | 1500 | 872 | 444 | 1,32 | 15,44 | 10,56 | 1 680 | 1 932 |
| | 8 | 360 | 1800 | 1040 | 530 | 1,32 | 18,32 | 12,48 | 1 754 | 2 017 |
| | 8 | 360 | 2000 | 1152 | 587 | 1,32 | 20,24 | 13,76 | 1 966 | 2 261 |
| | 8 | 360 | 2200 | 1264 | 644 | 1,32 | 22,24 | 15,04 | 2 398 | 2 758 |
| 11370 0450 1500 0099 YYY -0000 | 10 | 450 | 1500 | 1090 | 555 | 1,32 | 19,30 | 13,20 | 1 918 | 2 206 |
| | 10 | 450 | 1800 | 1300 | 662 | 1,32 | 22,90 | 15,60 | 2 165 | 2 490 |
| | 10 | 450 | 2000 | 1440 | 734 | 1,32 | 25,30 | 17,20 | 2 431 | 2 796 |
| | 10 | 450 | 2200 | 1580 | 805 | 1,32 | 27,80 | 18,80 | 2 761 | 3 175 |
| 11370 0540 1500 0099 YYY -0000 | 12 | 540 | 1500 | 1308 | 666 | 1,32 | 23,16 | 15,84 | 2 281 | 2 623 |
| | 12 | 540 | 1800 | 1560 | 795 | 1,32 | 27,48 | 18,72 | 2 639 | 3 035 |
| | 12 | 540 | 2000 | 1728 | 880 | 1,32 | 30,36 | 20,64 | 2 958 | 3 402 |
| | 12 | 540 | 2200 | 1896 | 966 | 1,32 | 33,36 | 22,56 | 3 354 | 3 857 |
| 11370 0630 1500 0099 YYY -0000 | 14 | 630 | 1500 | 1526 | 778 | 1,32 | 27,02 | 18,48 | 2 643 | 3 039 |
| | 14 | 630 | 1800 | 1820 | 927 | 1,32 | 32,06 | 21,84 | 3 051 | 3 509 |
| | 14 | 630 | 2000 | 2016 | 1027 | 1,32 | 35,42 | 24,08 | 3 423 | 3 936 |
| | 14 | 630 | 2200 | 2212 | 1127 | 1,32 | 38,92 | 26,32 | 3 885 | 4 468 |
| 11370 0720 1500 0099 YYY -0000 | 16 | 720 | 1500 | 1744 | 889 | 1,32 | 30,88 | 21,12 | 3 068 | 3 528 |
| | 16 | 720 | 1800 | 2080 | 1060 | 1,32 | 36,64 | 24,96 | 3 463 | 3 982 |
| | 16 | 720 | 2000 | 2304 | 1174 | 1,32 | 40,48 | 27,52 | 3 888 | 4 471 |
| | 16 | 720 | 2200 | 2528 | 1288 | 1,32 | 44,48 | 30,08 | 4 416 | 5 078 |

Zgodne z normą EN442-1: 2014:grzejniki i konwektory

PIONOWY (3-KOLUMNOWY)

JAK ZAMAWIAĆ GRZEJNIK RITMO PIONOWY

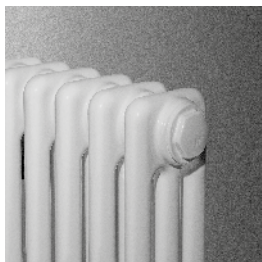

RITMO V-3K/105
(3-KOLUMNOWY)

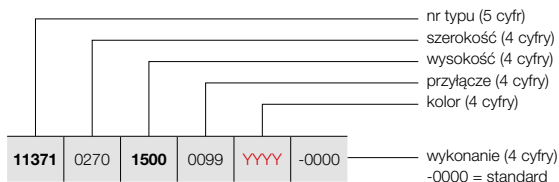

Wykaz zawiesi i konsol na str. 19 – 20

GRUPA PRODUKTÓW: KOLUMNOWE

| KOD PRODUKTU NA ZAMÓWIENIE RITMO PIONOWY | DANE TECHNICZNE | | | | | | | | KOLOR STANDARD BIAŁY RAL 9016 | KOLORY | |
|--|-----------------|----------------------|---------------------|-------------------------|-------------------------|---------------|--------------|----------------|----------------------------------|-------------------|-------|
| | Liczba rurek | Szerokość L mm | Wysokość H mm | 75/65/20 Wat φ50K | 55/45/20 Wat φ30K | Wyładnik n | Ciężar kg | Pojemność l | Cena netto PLN | Cena netto PLN | |
| V-3K/105 : 11371 | | | | | | | | | | | |
| 11371 0270 1500 0099 YYY -0000 | 1800 | 6 | 270 | 1500 | 882 | 443 | 1,35 | 17,34 | 11,76 | 1 657 | 1 906 |
| | 2000 | 6 | 270 | 1800 | 1038 | 521 | 1,35 | 20,58 | 13,92 | 1 948 | 2 240 |
| | 2200 | 6 | 270 | 2000 | 1140 | 575 | 1,34 | 22,80 | 15,36 | 2 094 | 2 408 |
| | | 6 | 270 | 2200 | 1242 | 626 | 1,34 | 24,96 | 16,80 | 2 403 | 2 763 |
| 11371 0360 1500 0099 YYY -0000 | 1800 | 8 | 360 | 1500 | 1176 | 590 | 1,35 | 23,12 | 15,68 | 2 174 | 2 500 |
| | 2000 | 8 | 360 | 1800 | 1384 | 694 | 1,35 | 27,44 | 18,56 | 2 562 | 2 946 |
| | 2200 | 8 | 360 | 2000 | 1520 | 767 | 1,34 | 30,40 | 20,48 | 2 757 | 3 171 |
| | | 8 | 360 | 2200 | 1656 | 835 | 1,34 | 33,28 | 22,40 | 3 169 | 3 644 |
| 11371 0450 1500 0099 YYY -0000 | 1800 | 10 | 450 | 1500 | 1470 | 738 | 1,35 | 28,90 | 19,60 | 2 691 | 3 095 |
| | 2000 | 10 | 450 | 1800 | 1730 | 868 | 1,35 | 34,30 | 23,20 | 3 175 | 3 651 |
| | 2200 | 10 | 450 | 2000 | 1900 | 958 | 1,34 | 38,00 | 25,60 | 3 419 | 3 932 |
| | | 10 | 450 | 2200 | 2070 | 1044 | 1,34 | 41,60 | 28,00 | 3 934 | 4 524 |
| 11371 0540 1500 0099 YYY -0000 | 1800 | 12 | 540 | 1500 | 1764 | 885 | 1,35 | 34,68 | 23,52 | 3 208 | 3 689 |
| | 2000 | 12 | 540 | 1800 | 2076 | 1042 | 1,35 | 41,16 | 27,84 | 3 851 | 4 429 |
| | 2200 | 12 | 540 | 2000 | 2280 | 1150 | 1,34 | 45,60 | 30,72 | 4 144 | 4 766 |
| | | 12 | 540 | 2200 | 2484 | 1253 | 1,34 | 49,92 | 33,60 | 4 762 | 5 476 |
| 11371 0630 1500 0099 YYY -0000 | 1800 | 14 | 630 | 1500 | 2058 | 1033 | 1,35 | 40,46 | 27,44 | 3 725 | 4 284 |
| | 2000 | 14 | 630 | 1800 | 2422 | 1215 | 1,35 | 48,02 | 32,48 | 4 465 | 5 135 |
| | 2200 | 14 | 630 | 2000 | 2660 | 1342 | 1,34 | 53,20 | 35,84 | 4 807 | 5 528 |
| | | 14 | 630 | 2200 | 2898 | 1462 | 1,34 | 58,24 | 39,20 | 5 528 | 6 357 |
| 11371 0720 1500 0099 YYY -0000 | 1800 | 16 | 720 | 1500 | 2352 | 1180 | 1,35 | 46,24 | 31,36 | 4 304 | 4 950 |
| | 2000 | 16 | 720 | 1800 | 2768 | 1389 | 1,35 | 54,88 | 37,12 | 5 079 | 5 841 |
| | 2200 | 16 | 720 | 2000 | 3040 | 1533 | 1,34 | 60,80 | 40,96 | 5 469 | 6 289 |
| | | 16 | 720 | 2200 | 3312 | 1670 | 1,34 | 66,56 | 44,80 | 6 293 | 7 237 |

Zgodne z normą EN442-1: 2014:grzejniki i konwektory

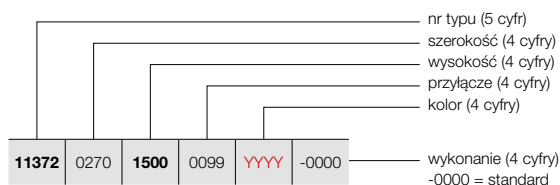

RITMO V-4K/145
(4-KOLUMNOWY)

Wykaz zawiesi i konsol na str. 19 – 20

GRUPA PRODUKTÓW: KOLUMNOWE

| KOD PRODUKTU NA ZAMÓWIENIE RITMO PIONOWY | DANE TECHNICZNE | | | | | | | | KOLOR STANDARD BIAŁY RAL 9016 | KOLORY | | | | | |
|--|-----------------|----------------------|---------------------|-------------------------|-------------------------|----------------|--------------|----------------|----------------------------------|-------------------|------|-------|-------|--------------|--------------|
| | Liczba rurek | Szerokość L mm | Wysokość H mm | 75/65/20 Wat φ50K | 55/45/20 Wat φ30K | Wykładnik n | Ciężar kg | Pojemność l | Cena netto PLN | Cena netto PLN | | | | | |
| V-4K/145 : 11372 | | | | | | | | | | | | | | | |
| 11372 | 0270 | 1500 | 0099 | YYYY | -0000 | 6 | 270 | 1500 | 1116 | 560 | 1,35 | 23,10 | 15,60 | 2 134 | 2 454 |
| | | 1800 | | | | 6 | 270 | 1800 | 1314 | 663 | 1,34 | 27,48 | 18,48 | 2 541 | 2 922 |
| | | 2000 | | | | 6 | 270 | 2000 | 1446 | 729 | 1,34 | 30,36 | 20,40 | 2 824 | 3 248 |
| | | 2200 | | | | 6 | 270 | 2200 | 1572 | 793 | 1,34 | 33,30 | 22,32 | 3 092 | 3 556 |
| 11372 | 0360 | 1500 | 0099 | YYYY | -0000 | 8 | 360 | 1500 | 1488 | 747 | 1,35 | 30,80 | 20,80 | 2 810 | 3 232 |
| | | 1800 | | | | 8 | 360 | 1800 | 1752 | 884 | 1,34 | 36,64 | 24,64 | 3 353 | 3 856 |
| | | 2000 | | | | 8 | 360 | 2000 | 1928 | 972 | 1,34 | 40,48 | 27,20 | 3 730 | 4 290 |
| | | 2200 | | | | 8 | 360 | 2200 | 2096 | 1057 | 1,34 | 44,40 | 29,76 | 4 087 | 4 700 |
| 11372 | 0450 | 1500 | 0099 | YYYY | -0000 | 10 | 450 | 1500 | 1860 | 933 | 1,35 | 38,50 | 26,00 | 3 486 | 4 009 |
| | | 1800 | | | | 10 | 450 | 1800 | 2190 | 1105 | 1,34 | 45,80 | 30,80 | 4 164 | 4 789 |
| | | 2000 | | | | 10 | 450 | 2000 | 2410 | 1215 | 1,34 | 50,60 | 34,00 | 4 635 | 5 330 |
| | | 2200 | | | | 10 | 450 | 2200 | 2620 | 1321 | 1,34 | 55,50 | 37,20 | 5 082 | 5 844 |
| 11372 | 0540 | 1500 | 0099 | YYYY | -0000 | 12 | 540 | 1500 | 2232 | 1120 | 1,35 | 46,20 | 31,20 | 4 162 | 4 786 |
| | | 1800 | | | | 12 | 540 | 1800 | 2628 | 1325 | 1,34 | 54,96 | 36,96 | 5 038 | 5 794 |
| | | 2000 | | | | 12 | 540 | 2000 | 2892 | 1459 | 1,34 | 60,72 | 40,80 | 5 603 | 6 443 |
| | | 2200 | | | | 12 | 540 | 2200 | 3144 | 1586 | 1,34 | 66,60 | 44,64 | 6 140 | 7 061 |
| 11372 | 0630 | 1500 | 0099 | YYYY | -0000 | 14 | 630 | 1500 | 2604 | 1307 | 1,35 | 53,90 | 36,40 | 4 838 | 5 564 |
| | | 1800 | | | | 14 | 630 | 1800 | 3066 | 1546 | 1,34 | 64,12 | 43,12 | 5 850 | 6 728 |
| | | 2000 | | | | 14 | 630 | 2000 | 3374 | 1702 | 1,34 | 70,84 | 47,60 | 6 509 | 7 485 |
| | | 2200 | | | | 14 | 630 | 2200 | 3668 | 1850 | 1,34 | 77,70 | 52,08 | 7 135 | 8 205 |
| 11372 | 0720 | 1500 | 0099 | YYYY | -0000 | 16 | 720 | 1500 | 2976 | 1493 | 1,35 | 61,60 | 41,60 | 5 576 | 6 412 |
| | | 1800 | | | | 16 | 720 | 1800 | 3504 | 1767 | 1,34 | 73,28 | 49,28 | 6 661 | 7 660 |
| | | 2000 | | | | 16 | 720 | 2000 | 3856 | 1945 | 1,34 | 80,96 | 54,40 | 7 415 | 8 527 |
| | | 2200 | | | | 16 | 720 | 2200 | 4192 | 2114 | 1,34 | 88,80 | 59,52 | 8 130 | 9 350 |

Zgodne z normą EN442-1: 2014:grzejniki i konwektory

BŁYSKAWICZNE OGRZEWANIE



Poziome grzejniki Ritmo są doskonałą propozycją do klasycznych i nowoczesnych pomieszczeń w typowych miejscach, np. pod oknami, parapetami lub w ciągach komunikacyjnych. Niezależnie od wielkości pomieszczenia i jego przeznaczenia z kolekcji Vasco Ritmo z pewnością dobierzesz grzejnik, który zaspokoi Twoje potrzeby.



RITMO H-2K/65 (2-KOLUMNOWY)



RITMO H-3K/105 (3-KOLUMNOWY)



RITMO H-4K/145 (4-KOLUMNOWY)

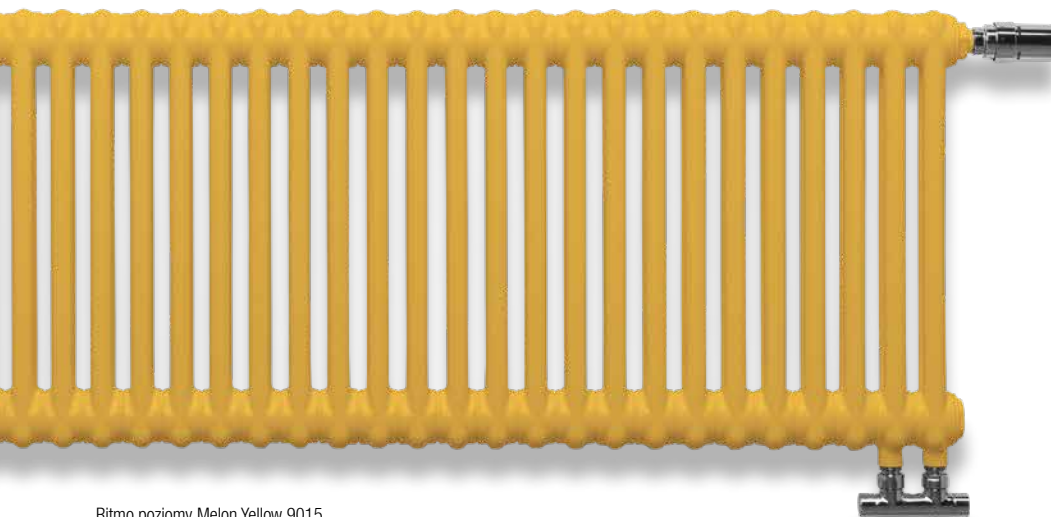

Ritmo poziomy Melon Yellow 9015

RITMO

POZIOMY

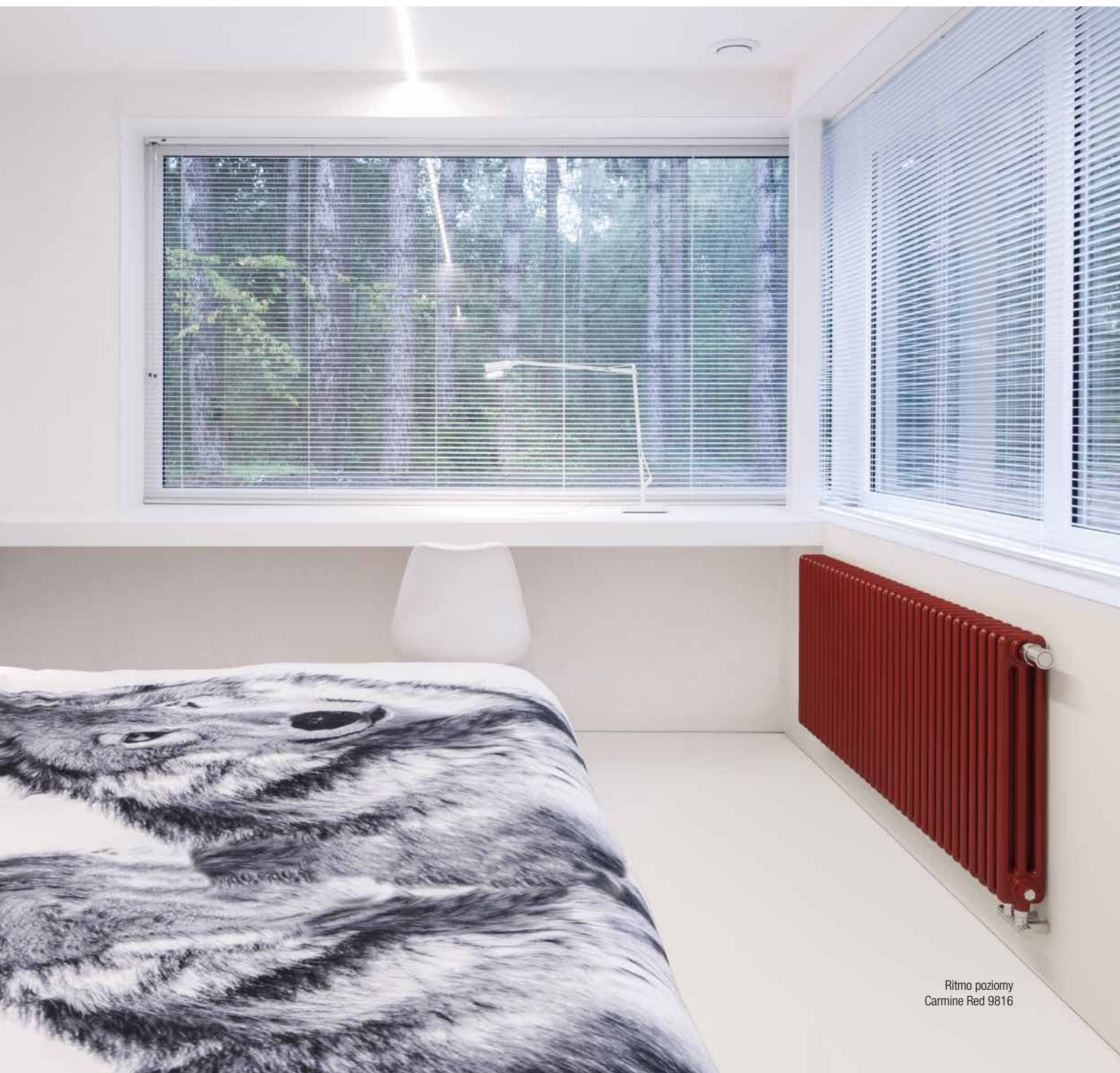

POZIOMY (H-2K/65, H-3K/105, H-4K/145)

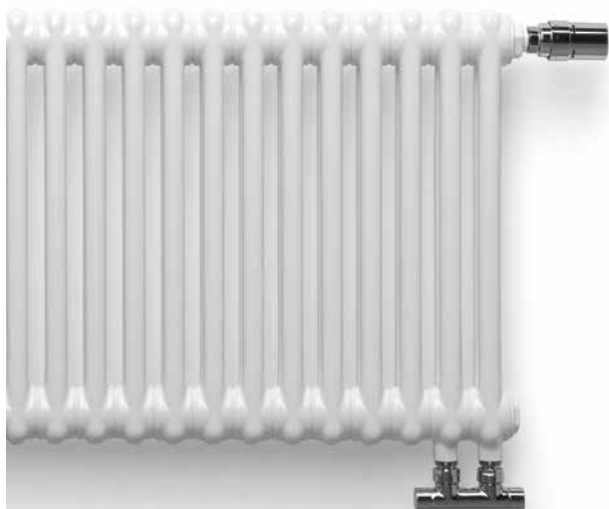

TYPY

- 2 / 3 / 4 kolumny
- Głębokość: 65 / 105 / 145 mm
- Wysokość: od 300 do 900 mm
- Długość: od 450 do 1800 mm

RURKI

- Pionowe, ϕ 25 mm

KOLORY

- Kolor standardowy biały RAL 9016
- Pozostałe kolory wg palety na str. 23

MOCOWANIE

- Montaż na podłodze lub na ścianie
- System do montażu na ścianie zamawiany osobno

DANE TECHNICZNE

- Okrągłe rury stalowe w układzie 2, 3, 4 kolumn
- Powłoka ATL, farba proszkowa
- Standardowe ciśnienie robocze: 10 bar
- Maksymalna temperatura robocza: 110°C

PODŁĄCZENIE

- Zasilanie 2-rurowe
- 4 podłączenia boczne, bez zaworu. Symbol podłączenia: 2367 lub
- Podłączenie zaworowe dolne – lewe/prawe – zamiennie. Wbudowana wkładka zaworowa M30 x 1,5. Symbol podłączenia: 0098. Dopłata za przyłącze zaworowe: 378 netto PLN

ZAWIESIA

- Zawiesia ścienne w kolorze grzejnika dostarczane w komplecie z grzejnikiem.
- Opis zestawów zawiesi ściennych oraz wykaz opcjonalnych konsoli podłogowych na str. 19 – 20

PODŁĄCZENIE ZAWOROWE

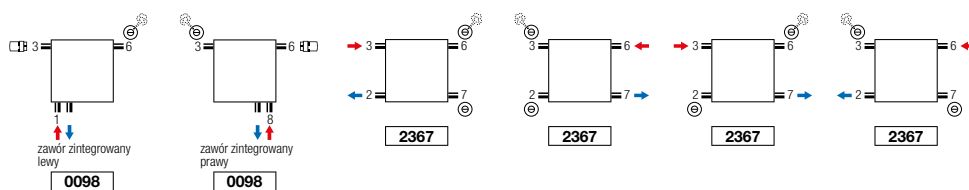

PORĘCZ NA RĘCZNIKI; CHROM



Nr kat. 11832650000099
Cena netto PLN: 602

BŁOK PRZYŁĄCZENIOWY KĄTOWY 1/2" GZ / 3/4" GZ; CHROM



Nr kat. 11823010000099
Cena netto PLN: 637

GŁOWICA TERMOSTATYCZNA, BIAŁA LUB CHROMOWANA



Nr kat. 11911630102
Cena netto PLN: 229

Nr kat. 11911631102
Cena netto PLN: 303



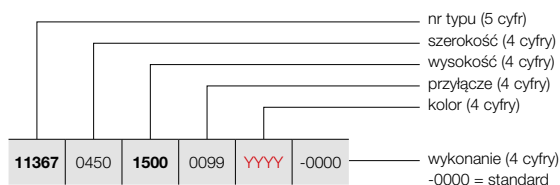

Wykaz zawiesi i konsol na str. 19 – 20

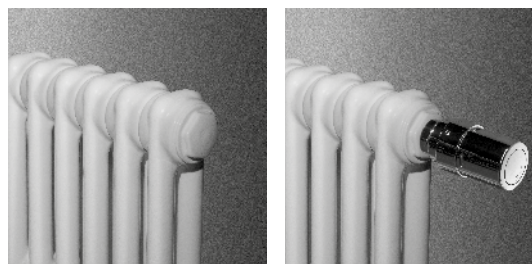

RITMO H-2K/65
(2-KOLUMNOWY)

RITMO H-2K/65
(2-KOLUMNOWY)
ZINTEGROWANY ZAWÓR

GRUPA PRODUKTÓW: KOLUMNOWE

| KOD PRODUKTU NA ZAMÓWIENIE RITMO POZIOMY | DANE TECHNICZNE | | | | | | | | KOLOR STANDARD BIAŁY RAL 9016 | KOLORY | | | | | |
|--|-----------------|----------------------|---------------------|-------------------------|-------------------------|----------------|--------------|----------------|----------------------------------|-------------------|------|-------|-------|-------|-------|
| | Liczba rurek | Szerokość L mm | Wysokość H mm | 75/65/20 Wat φ50K | 55/45/20 Wat φ30K | Wykładnik n | Ciężar kg | Pojemność l | Cena netto PLN | Cena netto PLN | | | | | |
| H-2K/65 : 11367 | | | | | | | | | | | | | | | |
| 11367 | 0450 | 0300 | XXXX | YYYY | -0000 | 10 | 450 | 300 | 240 | 126 | 1,26 | 4,70 | 3,70 | 1 068 | 1 228 |
| | | 0400 | | | | 10 | 450 | 400 | 310 | 159 | 1,31 | 5,90 | 4,50 | 1 110 | 1 277 |
| | | 0500 | | | | 10 | 450 | 500 | 390 | 200 | 1,31 | 7,10 | 5,30 | 1 116 | 1 283 |
| | | 0600 | | | | 10 | 450 | 600 | 460 | 123 | 1,31 | 8,30 | 6,10 | 1 185 | 1 363 |
| | | 0900 | | | | 10 | 450 | 900 | 670 | 343 | 1,31 | 12,00 | 8,40 | 1 338 | 1 539 |
| 11367 | 0540 | 0300 | XXXX | YYYY | -0000 | 12 | 540 | 300 | 288 | 151 | 1,26 | 5,64 | 4,44 | 1 261 | 1 450 |
| | | 0400 | | | | 12 | 540 | 400 | 372 | 191 | 1,31 | 7,08 | 5,40 | 1 311 | 1 508 |
| | | 0500 | | | | 12 | 540 | 500 | 468 | 240 | 1,31 | 8,52 | 6,36 | 1 318 | 1 516 |
| | | 0600 | | | | 12 | 540 | 600 | 552 | 147 | 1,31 | 9,96 | 7,32 | 1 369 | 1 574 |
| | | 0900 | | | | 12 | 540 | 900 | 804 | 412 | 1,31 | 14,40 | 10,08 | 1 585 | 1 823 |
| 11367 | 0630 | 0300 | XXXX | YYYY | -0000 | 14 | 630 | 300 | 336 | 177 | 1,26 | 6,58 | 5,18 | 1 453 | 1 671 |
| | | 0400 | | | | 14 | 630 | 400 | 434 | 222 | 1,31 | 8,26 | 6,30 | 1 512 | 1 739 |
| | | 0500 | | | | 14 | 630 | 500 | 546 | 280 | 1,31 | 9,94 | 7,42 | 1 520 | 1 748 |
| | | 0600 | | | | 14 | 630 | 600 | 644 | 172 | 1,31 | 11,62 | 8,54 | 1 579 | 1 816 |
| | | 0900 | | | | 14 | 630 | 900 | 938 | 480 | 1,31 | 16,80 | 11,76 | 1 831 | 2 106 |
| 11367 | 0720 | 0300 | XXXX | YYYY | -0000 | 16 | 720 | 300 | 384 | 202 | 1,26 | 7,52 | 5,92 | 1 646 | 1 893 |
| | | 0400 | | | | 16 | 720 | 400 | 496 | 254 | 1,31 | 9,44 | 7,20 | 1 713 | 1 970 |
| | | 0500 | | | | 16 | 720 | 500 | 624 | 320 | 1,31 | 11,36 | 8,48 | 1 722 | 1 980 |
| | | 0600 | | | | 16 | 720 | 600 | 736 | 197 | 1,31 | 13,28 | 9,76 | 1 790 | 2 059 |
| | | 0900 | | | | 16 | 720 | 900 | 1072 | 549 | 1,31 | 19,20 | 13,44 | 2 078 | 2 390 |
| 11367 | 0810 | 0300 | XXXX | YYYY | -0000 | 18 | 810 | 300 | 432 | 227 | 1,26 | 8,46 | 6,66 | 1 838 | 2 114 |
| | | 0400 | | | | 18 | 810 | 400 | 558 | 286 | 1,31 | 10,62 | 8,10 | 1 914 | 2 201 |
| | | 0500 | | | | 18 | 810 | 500 | 702 | 360 | 1,31 | 12,78 | 9,54 | 1 924 | 2 213 |
| | | 0600 | | | | 18 | 810 | 600 | 828 | 221 | 1,31 | 14,94 | 10,98 | 2 000 | 2 300 |
| | | 0900 | | | | 18 | 810 | 900 | 1206 | 618 | 1,31 | 21,60 | 15,12 | 2 324 | 2 673 |
| 11367 | 0900 | 0300 | XXXX | YYYY | -0000 | 20 | 900 | 300 | 480 | 252 | 1,26 | 9,40 | 7,40 | 2 030 | 2 335 |
| | | 0400 | | | | 20 | 900 | 400 | 620 | 318 | 1,31 | 11,80 | 9,00 | 2 114 | 2 431 |
| | | 0500 | | | | 20 | 900 | 500 | 780 | 399 | 1,31 | 14,20 | 10,60 | 2 126 | 2 445 |
| | | 0600 | | | | 20 | 900 | 600 | 920 | 246 | 1,31 | 16,60 | 12,20 | 2 210 | 2 542 |
| | | 0900 | | | | 20 | 900 | 900 | 1340 | 686 | 1,31 | 24,00 | 16,80 | 2 570 | 2 956 |
| 11367 | 0990 | 0300 | XXXX | YYYY | -0000 | 22 | 990 | 300 | 528 | 277 | 1,26 | 10,34 | 8,14 | 2 223 | 2 556 |
| | | 0400 | | | | 22 | 990 | 400 | 682 | 349 | 1,31 | 12,98 | 9,90 | 2 315 | 2 662 |
| | | 0500 | | | | 22 | 990 | 500 | 858 | 439 | 1,31 | 15,62 | 11,66 | 2 328 | 2 677 |
| | | 0600 | | | | 22 | 990 | 600 | 1012 | 270 | 1,31 | 18,26 | 13,42 | 2 421 | 2 784 |
| | | 0900 | | | | 22 | 990 | 900 | 1474 | 755 | 1,31 | 26,40 | 18,48 | 2 817 | 3 240 |
| 11367 | 1080 | 0300 | XXXX | YYYY | -0000 | 24 | 1080 | 300 | 576 | 303 | 1,26 | 11,28 | 8,88 | 2 477 | 2 849 |
| | | 0400 | | | | 24 | 1080 | 400 | 744 | 381 | 1,31 | 14,16 | 10,80 | 2 578 | 2 965 |
| | | 0500 | | | | 24 | 1080 | 500 | 936 | 479 | 1,31 | 17,04 | 12,72 | 2 592 | 2 981 |
| | | 0600 | | | | 24 | 1080 | 600 | 1104 | 295 | 1,31 | 19,92 | 14,64 | 2 693 | 3 097 |
| | | 0900 | | | | 24 | 1080 | 900 | 1608 | 824 | 1,31 | 28,80 | 20,16 | 3 125 | 3 594 |

Zgodne z normą EN442-1: 2014:grzejniki i konwektory

POZIOMY (2-KOLUMNOWY)

JAK ZAMAWIĄĆ GRZEJNIK RITMO POZIOMY

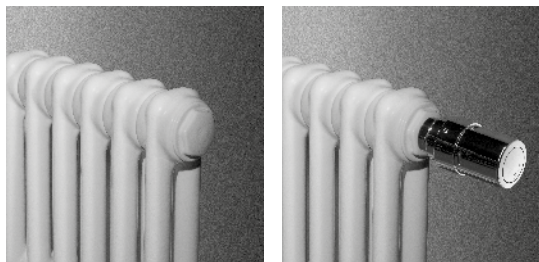

RITMO H-2K/65
(2-KOLUMNOWY)

RITMO H-2K/65
(2-KOLUMNOWY)
ZINTEGROWANY ZAWÓR

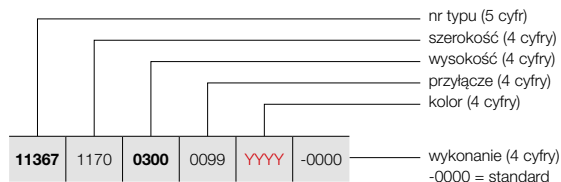

Wykaz zawiesi i konsol na str. 19 – 20

GRUPA PRODUKTÓW: KOLUMNOWE

| KOD PRODUKTU NA ZAMÓWIENIE RITMO POZIOMY | | | | | | DANE TECHNICZNE | | | | KOLOR STANDARD BIAŁY RAL 9016 | | KOLORY | | | |
|--|------|------|------|------|-------|-----------------|----------------------|---------------------|-------------------------|----------------------------------|----------------|--------------|----------------|-------------------|-------------------|
| | | | | | | Liczba rurek | Szerokość L mm | Wysokość H mm | 75/65/20 Wat φ50K | 55/45/20 Wat φ30K | Wykładnik n | Ciężar kg | Pojemność l | Cena netto PLN | Cena netto PLN |
| H-2K/65 : 11367 | | | | | | | | | | | | | | | |
| 11367 | 1170 | 0300 | XXXX | YYYY | -0000 | 26 | 1170 | 300 | 624 | 328 | 1,26 | 12,22 | 9,62 | 2 670 | 3 071 |
| | | 0400 | | | | 26 | 1170 | 400 | 806 | 413 | 1,31 | 15,34 | 11,70 | 2 779 | 3 196 |
| | | 0500 | | | | 26 | 1170 | 500 | 1014 | 519 | 1,31 | 18,46 | 13,78 | 2 794 | 3 213 |
| | | 0600 | | | | 26 | 1170 | 600 | 1196 | 320 | 1,31 | 21,58 | 15,86 | 2 904 | 3 340 |
| | | 0900 | | | | 26 | 1170 | 900 | 1742 | 892 | 1,31 | 31,20 | 21,84 | 3 372 | 3 878 |
| 11367 | 1260 | 0300 | XXXX | YYYY | -0000 | 28 | 1260 | 300 | 672 | 353 | 1,26 | 13,16 | 10,36 | 2 862 | 3 291 |
| | | 0400 | | | | 28 | 1260 | 400 | 868 | 445 | 1,31 | 16,52 | 12,60 | 2 980 | 3 427 |
| | | 0500 | | | | 28 | 1260 | 500 | 1092 | 559 | 1,31 | 19,88 | 14,84 | 2 996 | 3 445 |
| | | 0600 | | | | 28 | 1260 | 600 | 1288 | 344 | 1,31 | 23,21 | 17,08 | 3 114 | 3 581 |
| | | 0900 | | | | 28 | 1260 | 900 | 1876 | 961 | 1,31 | 33,60 | 23,52 | 3 618 | 4 161 |
| 11367 | 1350 | 0300 | XXXX | YYYY | -0000 | 30 | 1350 | 300 | 720 | 378 | 1,26 | 14,10 | 11,10 | 3 054 | 3 512 |
| | | 0400 | | | | 30 | 1350 | 400 | 930 | 476 | 1,31 | 17,70 | 13,50 | 3 180 | 3 657 |
| | | 0500 | | | | 30 | 1350 | 500 | 1170 | 599 | 1,31 | 21,30 | 15,90 | 3 198 | 3 678 |
| | | 0600 | | | | 30 | 1350 | 600 | 1380 | 369 | 1,31 | 24,90 | 18,30 | 3 324 | 3 823 |
| | | 0900 | | | | 30 | 1350 | 900 | 2010 | 1029 | 1,31 | 36,00 | 25,20 | 3 864 | 4 444 |
| 11367 | 1440 | 0300 | XXXX | YYYY | -0000 | 32 | 1440 | 300 | 768 | 403 | 1,26 | 15,04 | 11,84 | 3 247 | 3 734 |
| | | 0400 | | | | 32 | 1440 | 400 | 992 | 508 | 1,31 | 18,88 | 14,40 | 3 381 | 3 888 |
| | | 0500 | | | | 32 | 1440 | 500 | 1248 | 639 | 1,31 | 22,72 | 16,96 | 3 400 | 3 910 |
| | | 0600 | | | | 32 | 1440 | 600 | 1472 | 393 | 1,31 | 26,56 | 19,52 | 3 535 | 4 065 |
| | | 0900 | | | | 32 | 1440 | 900 | 2144 | 1098 | 1,31 | 38,40 | 26,88 | 4 111 | 4 728 |
| 11367 | 1530 | 0300 | XXXX | YYYY | -0000 | 34 | 1530 | 300 | 816 | 429 | 1,26 | 15,98 | 12,58 | 3 439 | 3 955 |
| | | 0400 | | | | 34 | 1530 | 400 | 1054 | 540 | 1,31 | 20,06 | 15,30 | 3 582 | 4 119 |
| | | 0500 | | | | 34 | 1530 | 500 | 1326 | 679 | 1,31 | 24,14 | 18,02 | 3 602 | 4 142 |
| | | 0600 | | | | 34 | 1530 | 600 | 1564 | 418 | 1,31 | 28,22 | 20,74 | 3 745 | 4 307 |
| | | 0900 | | | | 34 | 1530 | 900 | 2278 | 1167 | 1,31 | 40,80 | 28,56 | 4 357 | 5 011 |
| 11367 | 1620 | 0300 | XXXX | YYYY | -0000 | 36 | 1620 | 300 | 864 | 454 | 1,26 | 16,92 | 13,32 | 3 632 | 4 177 |
| | | 0400 | | | | 36 | 1620 | 400 | 1116 | 572 | 1,31 | 21,24 | 16,20 | 3 783 | 4 350 |
| | | 0500 | | | | 36 | 1620 | 500 | 1404 | 719 | 1,31 | 25,56 | 19,08 | 3 804 | 4 375 |
| | | 0600 | | | | 36 | 1620 | 600 | 1656 | 442 | 1,31 | 29,88 | 21,96 | 3 956 | 4 549 |
| | | 0900 | | | | 36 | 1620 | 900 | 2412 | 1235 | 1,31 | 43,20 | 30,24 | 4 604 | 5 295 |
| 11367 | 1710 | 0300 | XXXX | YYYY | -0000 | 38 | 1710 | 300 | 912 | 479 | 1,26 | 17,86 | 14,06 | 3 824 | 4 398 |
| | | 0400 | | | | 38 | 1710 | 400 | 1178 | 603 | 1,31 | 22,42 | 17,10 | 3 984 | 4 582 |
| | | 0500 | | | | 38 | 1710 | 500 | 1482 | 759 | 1,31 | 26,98 | 20,14 | 4 006 | 4 607 |
| | | 0600 | | | | 38 | 1710 | 600 | 1748 | 467 | 1,31 | 31,54 | 23,18 | 4 166 | 4 791 |
| | | 0900 | | | | 38 | 1710 | 900 | 2546 | 1304 | 1,31 | 45,60 | 31,92 | 4 850 | 5 578 |
| 11367 | 1800 | 0300 | XXXX | YYYY | -0000 | 40 | 1800 | 300 | 960 | 504 | 1,26 | 18,80 | 14,80 | 4 066 | 4 676 |
| | | 0400 | | | | 40 | 1800 | 400 | 1240 | 635 | 1,31 | 23,60 | 18,00 | 4 234 | 4 869 |
| | | 0500 | | | | 40 | 1800 | 500 | 1560 | 799 | 1,31 | 28,40 | 21,20 | 4 258 | 4 897 |
| | | 0600 | | | | 40 | 1800 | 600 | 1840 | 492 | 1,31 | 33,20 | 24,40 | 4 426 | 5 090 |
| | | 0900 | | | | 40 | 1800 | 900 | 2680 | 1373 | 1,31 | 48,00 | 33,60 | 5 146 | 5 918 |

Zgodne z normą EN442-1: 2014:grzejniki i konwektory

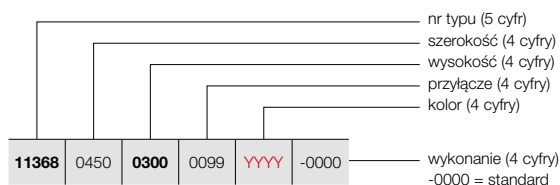

Wykaz zawiesi i konsol na str. 19 – 20

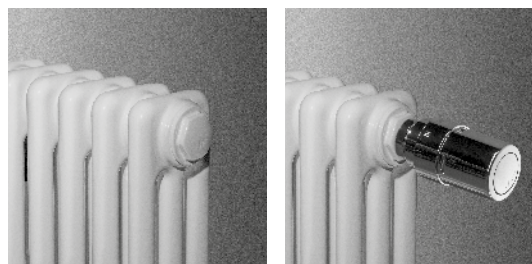

RITMO H-3K/105
(3-KOLUMNOWY)

RITMO H-3K/105
(3-KOLUMNOWY)
ZINTEGROWANY ZAWÓR

GRUPA PRODUKTÓW: KOLUMNOWE

| KOD PRODUKTU NA ZAMÓWIENIE RITMO POZIOMY | DANE TECHNICZNE | | | | | | | | KOLOR STANDARD BIAŁY RAL 9016 | KOLORY | | | | | |
|--|-----------------|----------------|---------------|-------------------|-------------------|-------------|-------------|-------------|-------------------------------|----------------|------|-------|-------|-------|-------|
| | Liczba rurek | Szerokość L mm | Wysokość H mm | 75/65/20 Wat φ50K | 55/45/20 Wat φ30K | Wykładnik n | Ciepłota kg | Pojemność l | Cena netto PLN | Cena netto PLN | | | | | |
| H-3K/105 : 11368 | | | | | | | | | | | | | | | |
| 11368 | 0450 | 0300 | XXXX | YYYY | -0000 | 10 | 450 | 300 | 330 | 167 | 1,33 | 7,00 | 5,30 | 1 151 | 1 324 |
| | | 0400 | | | | 10 | 450 | 400 | 430 | 215 | 1,36 | 8,80 | 6,50 | 1 223 | 1 406 |
| | | 0500 | | | | 10 | 450 | 500 | 530 | 265 | 1,36 | 10,60 | 7,70 | 1 244 | 1 431 |
| | | 0600 | | | | 10 | 450 | 600 | 630 | 315 | 1,36 | 12,50 | 8,90 | 1 304 | 1 500 |
| | | 0900 | | | | 10 | 450 | 900 | 920 | 459 | 1,36 | 17,90 | 12,50 | 1 554 | 1 787 |
| 11368 | 0540 | 0300 | XXXX | YYYY | -0000 | 12 | 540 | 300 | 396 | 201 | 1,33 | 8,40 | 6,36 | 1 360 | 1 564 |
| | | 0400 | | | | 12 | 540 | 400 | 516 | 258 | 1,36 | 10,56 | 7,80 | 1 447 | 1 664 |
| | | 0500 | | | | 12 | 540 | 500 | 636 | 258 | 1,36 | 12,72 | 9,24 | 1 472 | 1 693 |
| | | 0600 | | | | 12 | 540 | 600 | 756 | 377 | 1,36 | 15,00 | 10,68 | 1 544 | 1 776 |
| | | 0900 | | | | 12 | 540 | 900 | 1104 | 551 | 1,36 | 21,48 | 15,00 | 1 844 | 2 121 |
| 11368 | 0630 | 0300 | XXXX | YYYY | -0000 | 14 | 630 | 300 | 462 | 234 | 1,33 | 9,80 | 7,42 | 1 569 | 1 804 |
| | | 0400 | | | | 14 | 630 | 400 | 602 | 301 | 1,36 | 12,32 | 9,10 | 1 670 | 1 921 |
| | | 0500 | | | | 14 | 630 | 500 | 742 | 301 | 1,36 | 14,84 | 10,78 | 1 700 | 1 955 |
| | | 0600 | | | | 14 | 630 | 600 | 882 | 440 | 1,36 | 17,50 | 12,46 | 1 784 | 2 052 |
| | | 0900 | | | | 14 | 630 | 900 | 1288 | 643 | 1,36 | 25,06 | 17,50 | 2 134 | 2 454 |
| 11368 | 0720 | 0300 | XXXX | YYYY | -0000 | 16 | 720 | 300 | 528 | 268 | 1,33 | 11,20 | 8,48 | 1 778 | 2 045 |
| | | 0400 | | | | 16 | 720 | 400 | 688 | 343 | 1,36 | 14,08 | 10,40 | 1 894 | 2 178 |
| | | 0500 | | | | 16 | 720 | 500 | 848 | 343 | 1,36 | 16,96 | 12,32 | 1 927 | 2 216 |
| | | 0600 | | | | 16 | 720 | 600 | 1008 | 503 | 1,36 | 20,00 | 14,24 | 2 023 | 2 326 |
| | | 0900 | | | | 16 | 720 | 900 | 1472 | 735 | 1,36 | 28,64 | 20,00 | 2 423 | 2 786 |
| 11368 | 0810 | 0300 | XXXX | YYYY | -0000 | 18 | 810 | 300 | 594 | 301 | 1,33 | 12,60 | 9,54 | 1 987 | 2 285 |
| | | 0400 | | | | 18 | 810 | 400 | 774 | 386 | 1,36 | 15,84 | 11,70 | 2 117 | 2 435 |
| | | 0500 | | | | 18 | 810 | 500 | 954 | 386 | 1,36 | 19,08 | 13,86 | 2 155 | 2 478 |
| | | 0600 | | | | 18 | 810 | 600 | 1134 | 566 | 1,36 | 22,50 | 16,02 | 2 263 | 2 602 |
| | | 0900 | | | | 18 | 810 | 900 | 1656 | 827 | 1,36 | 32,22 | 22,50 | 2 713 | 3 120 |
| 11368 | 0900 | 0300 | XXXX | YYYY | -0000 | 20 | 900 | 300 | 660 | 335 | 1,33 | 14,00 | 10,60 | 2 196 | 2 525 |
| | | 0400 | | | | 20 | 900 | 400 | 860 | 429 | 1,36 | 17,60 | 13,00 | 2 340 | 2 691 |
| | | 0500 | | | | 20 | 900 | 500 | 1060 | 429 | 1,36 | 21,20 | 15,40 | 2 382 | 2 739 |
| | | 0600 | | | | 20 | 900 | 600 | 1260 | 629 | 1,36 | 25,00 | 17,80 | 2 502 | 2 877 |
| | | 0900 | | | | 20 | 900 | 900 | 1840 | 919 | 1,36 | 35,80 | 25,00 | 3 002 | 3 452 |
| 11368 | 0990 | 0300 | XXXX | YYYY | -0000 | 22 | 990 | 300 | 726 | 368 | 1,33 | 15,40 | 11,66 | 2 405 | 2 766 |
| | | 0400 | | | | 22 | 990 | 400 | 946 | 472 | 1,36 | 19,36 | 14,30 | 2 564 | 2 949 |
| | | 0500 | | | | 22 | 990 | 500 | 1166 | 472 | 1,36 | 23,32 | 16,94 | 2 610 | 3 002 |
| | | 0600 | | | | 22 | 990 | 600 | 1386 | 692 | 1,36 | 27,50 | 19,58 | 2 742 | 3 153 |
| | | 0900 | | | | 22 | 990 | 900 | 2024 | 1010 | 1,36 | 39,38 | 27,50 | 3 292 | 3 786 |
| 11368 | 1080 | 0300 | XXXX | YYYY | -0000 | 24 | 1080 | 300 | 792 | 401 | 1,33 | 16,80 | 12,72 | 2 676 | 3 077 |
| | | 0400 | | | | 24 | 1080 | 400 | 1032 | 515 | 1,36 | 21,12 | 15,60 | 2 849 | 3 276 |
| | | 0500 | | | | 24 | 1080 | 500 | 1272 | 515 | 1,36 | 25,44 | 18,48 | 2 900 | 3 335 |
| | | 0600 | | | | 24 | 1080 | 600 | 1512 | 755 | 1,36 | 30,00 | 21,36 | 3 044 | 3 501 |
| | | 0900 | | | | 24 | 1080 | 900 | 2208 | 1102 | 1,36 | 42,96 | 30,00 | 3 644 | 4 191 |

Zgodne z normą EN442-1: 2014:grzejniki i konwektory

POZIOMY (3-KOLUMNOWY)

JAK ZAMAWIĄĆ GRZEJNIK RITMO POZIOMY

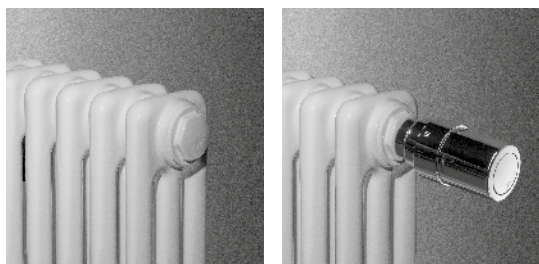

RITMO H-3K/105
(3-KOLUMNOWY)

RITMO H-3K/105
(3-KOLUMNOWY)
ZINTEGROWANY ZAWÓR

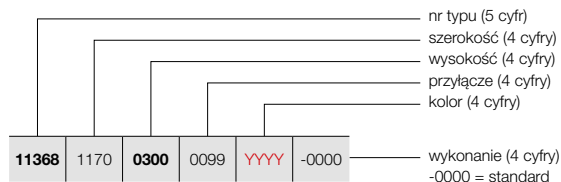

Wykaz zawiesi i konsol na str. 19 – 20

GRUPA PRODUKTÓW: KOLUMNOWE

| KOD PRODUKTU NA ZAMÓWIENIE RITMO POZIOMY | DANE TECHNICZNE | | | | | | | | KOLOR STANDARD BIAŁY RAL 9016 | KOLORY | | | | | |
|--|-----------------|----------------------|---------------------|-------------------------|-------------------------|---------------|--------------|----------------|----------------------------------|-------------------|-------|-------|-------|-------|-------|
| | Liczba rurek | Szerokość L mm | Wysokość H mm | 75/65/20 Wat φ50K | 55/45/20 Wat φ30K | Wyładnik n | Ciężar kg | Pojemność l | Cena netto PLN | Cena netto PLN | | | | | |
| H-3K/105 : 11368 | | | | | | | | | | | | | | | |
| 11368 | 1170 | 0300 | XXXX | YYYY | -0000 | 26 | 1170 | 300 | 858 | 435 | 1,33 | 18,20 | 13,78 | 2 885 | 3 318 |
| | | | 0400 | 26 | | 1170 | 400 | 1118 | 558 | 1,36 | 22,88 | 16,90 | 3 073 | 3 534 | |
| | | | 0500 | 26 | | 1170 | 500 | 1378 | 558 | 1,36 | 27,56 | 20,02 | 3 127 | 3 596 | |
| | | | 0600 | 26 | | 1170 | 600 | 1638 | 818 | 1,36 | 32,50 | 23,14 | 3 283 | 3 775 | |
| | | | 0900 | 26 | | 1170 | 900 | 2392 | 1194 | 1,36 | 46,54 | 32,50 | 3 933 | 4 523 | |
| 11368 | 1260 | 0300 | XXXX | YYYY | -0000 | 28 | 1260 | 300 | 924 | 468 | 1,33 | 19,60 | 14,84 | 3 094 | 3 558 |
| | | | 0400 | 28 | | 1260 | 400 | 1204 | 601 | 1,36 | 24,64 | 18,20 | 3 296 | 3 790 | |
| | | | 0500 | 28 | | 1260 | 500 | 1484 | 601 | 1,36 | 29,68 | 21,56 | 3 355 | 3 858 | |
| | | | 0600 | 28 | | 1260 | 600 | 1764 | 881 | 1,36 | 35,00 | 24,92 | 3 523 | 4 051 | |
| | | | 0900 | 28 | | 1260 | 900 | 2576 | 1286 | 1,36 | 50,12 | 35,00 | 4 223 | 4 856 | |
| 11368 | 1350 | 0300 | XXXX | YYYY | -0000 | 30 | 1350 | 300 | 990 | 502 | 1,33 | 21,00 | 15,90 | 3 303 | 3 798 |
| | | | 0400 | 30 | | 1350 | 400 | 1290 | 644 | 1,36 | 26,40 | 19,50 | 3 519 | 4 047 | |
| | | | 0500 | 30 | | 1350 | 500 | 1590 | 644 | 1,36 | 31,80 | 23,10 | 3 582 | 4 119 | |
| | | | 0600 | 30 | | 1350 | 600 | 1890 | 944 | 1,36 | 37,50 | 26,70 | 3 762 | 4 326 | |
| | | | 0900 | 30 | | 1350 | 900 | 2760 | 1378 | 1,36 | 53,70 | 37,50 | 4 512 | 5 189 | |
| 11368 | 1440 | 0300 | XXXX | YYYY | -0000 | 32 | 1440 | 300 | 1056 | 535 | 1,33 | 22,40 | 16,96 | 3 512 | 4 039 |
| | | | 0400 | 32 | | 1440 | 400 | 1376 | 687 | 1,36 | 28,16 | 20,80 | 3 743 | 4 304 | |
| | | | 0500 | 32 | | 1440 | 500 | 1696 | 687 | 1,36 | 33,92 | 24,64 | 3 810 | 4 382 | |
| | | | 0600 | 32 | | 1440 | 600 | 2016 | 1006 | 1,36 | 40,00 | 28,48 | 4 002 | 4 602 | |
| | | | 0900 | 32 | | 1440 | 900 | 2944 | 1470 | 1,36 | 57,28 | 40,00 | 4 802 | 5 522 | |
| 11368 | 1530 | 0300 | XXXX | YYYY | -0000 | 34 | 1530 | 300 | 1122 | 569 | 1,33 | 23,80 | 18,02 | 3 721 | 4 279 |
| | | | 0400 | 34 | | 1530 | 400 | 1462 | 730 | 1,36 | 29,92 | 22,10 | 3 966 | 4 561 | |
| | | | 0500 | 34 | | 1530 | 500 | 1802 | 730 | 1,36 | 36,04 | 26,18 | 4 038 | 4 644 | |
| | | | 0600 | 34 | | 1530 | 600 | 2142 | 1069 | 1,36 | 42,50 | 30,26 | 4 242 | 4 878 | |
| | | | 0900 | 34 | | 1530 | 900 | 3128 | 1562 | 1,36 | 60,86 | 42,50 | 5 092 | 5 856 | |
| 11368 | 1620 | 0300 | XXXX | YYYY | -0000 | 36 | 1620 | 300 | 1188 | 602 | 1,33 | 25,20 | 19,08 | 3 930 | 4 520 |
| | | | 0400 | 36 | | 1620 | 400 | 1548 | 773 | 1,36 | 31,68 | 23,40 | 4 190 | 4 819 | |
| | | | 0500 | 36 | | 1620 | 500 | 1908 | 773 | 1,36 | 38,16 | 27,72 | 4 265 | 4 905 | |
| | | | 0600 | 36 | | 1620 | 600 | 2268 | 1132 | 1,36 | 45,00 | 32,04 | 4 481 | 5 153 | |
| | | | 0900 | 36 | | 1620 | 900 | 3312 | 1653 | 1,36 | 64,44 | 45,00 | 5 381 | 6 188 | |
| 11368 | 1710 | 0300 | XXXX | YYYY | -0000 | 38 | 1710 | 300 | 1254 | 636 | 1,33 | 26,60 | 20,14 | 4 139 | 4 760 |
| | | | 0400 | 38 | | 1710 | 400 | 1634 | 816 | 1,36 | 33,44 | 24,70 | 4 413 | 5 075 | |
| | | | 0500 | 38 | | 1710 | 500 | 2014 | 816 | 1,36 | 40,28 | 29,26 | 4 493 | 5 167 | |
| | | | 0600 | 38 | | 1710 | 600 | 2394 | 1195 | 1,36 | 47,50 | 33,82 | 4 721 | 5 429 | |
| | | | 0900 | 38 | | 1710 | 900 | 3496 | 1745 | 1,36 | 68,02 | 47,50 | 5 671 | 6 522 | |
| 11368 | 1800 | 0300 | XXXX | YYYY | -0000 | 40 | 1800 | 300 | 1320 | 669 | 1,33 | 28,00 | 21,20 | 4 398 | 5 058 |
| | | | 0400 | 40 | | 1800 | 400 | 1720 | 859 | 1,36 | 35,20 | 26,00 | 4 686 | 5 389 | |
| | | | 0500 | 40 | | 1800 | 500 | 2120 | 859 | 1,36 | 42,40 | 30,80 | 4 770 | 5 486 | |
| | | | 0600 | 40 | | 1800 | 600 | 2520 | 1258 | 1,36 | 50,00 | 35,60 | 5 010 | 5 762 | |
| | | | 0900 | 40 | | 1800 | 900 | 3680 | 1837 | 1,36 | 71,60 | 50,00 | 6 010 | 6 912 | |

Zgodne z normą EN442-1: 2014:grzejniki i konwektory

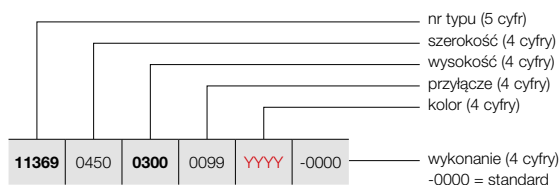

Wykaz zawiesi i konsol na str. 19 – 20

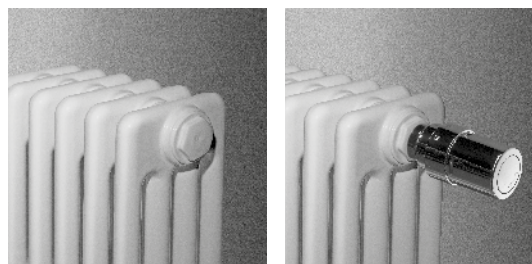

RITMO H-4K/145
(4-KOLUMNOWY)

RITMO H-4K/145
(4-KOLUMNOWY)
ZINTEGROWANY ZAWÓR

GRUPA PRODUKTÓW: KOLUMNOWE

| KOD PRODUKTU NA ZAMÓWIENIE RITMO POZIOMY | DANE TECHNICZNE | | | | | | | | KOLOR STANDARD BIAŁY RAL 9016 | KOLORY | | | | | |
|--|-----------------|----------------------|---------------------|-------------------------|-------------------------|----------------|--------------|----------------|----------------------------------|-------------------|------|-------|-------|-------|-------|
| | Liczba rurek | Szerokość L mm | Wysokość H mm | 75/65/20 Wat φ50K | 55/45/20 Wat φ30K | Wykładnik n | Ciężar kg | Pojemność l | Cena netto PLN | Cena netto PLN | | | | | |
| H-4K/145 : 11369 | | | | | | | | | | | | | | | |
| 11369 | 0450 | 0300 | XXXX | YYYY | -0000 | 10 | 450 | 300 | 430 | 218 | 1,33 | 9,30 | 6,90 | 1 272 | 1 463 |
| | | 0400 | | | | 10 | 450 | 400 | 560 | 281 | 1,35 | 11,80 | 8,50 | 1 336 | 1 536 |
| | | 0500 | | | | 10 | 450 | 500 | 690 | 346 | 1,35 | 14,20 | 10,10 | 1 450 | 1 668 |
| | | 0600 | | | | 10 | 450 | 600 | 810 | 406 | 1,35 | 16,60 | 11,70 | 1 486 | 1 709 |
| | | 0900 | | | | 10 | 450 | 900 | 1170 | 587 | 1,35 | 23,90 | 16,50 | 1 966 | 2 261 |
| 11369 | 0540 | 0300 | XXXX | YYYY | -0000 | 12 | 540 | 300 | 516 | 262 | 1,33 | 11,16 | 8,28 | 1 506 | 1 732 |
| | | 0400 | | | | 12 | 540 | 400 | 672 | 337 | 1,35 | 14,16 | 10,20 | 1 582 | 1 819 |
| | | 0500 | | | | 12 | 540 | 500 | 828 | 415 | 1,35 | 17,04 | 12,12 | 1 632 | 1 877 |
| | | 0600 | | | | 12 | 540 | 600 | 972 | 488 | 1,35 | 19,92 | 14,04 | 1 762 | 2 026 |
| | | 0900 | | | | 12 | 540 | 900 | 1404 | 704 | 1,35 | 28,68 | 19,80 | 2 338 | 2 689 |
| 11369 | 0630 | 0300 | XXXX | YYYY | -0000 | 14 | 630 | 300 | 602 | 305 | 1,33 | 13,02 | 9,66 | 1 739 | 2 000 |
| | | 0400 | | | | 14 | 630 | 400 | 784 | 393 | 1,35 | 16,52 | 11,90 | 1 828 | 2 102 |
| | | 0500 | | | | 14 | 630 | 500 | 966 | 485 | 1,35 | 19,88 | 14,14 | 1 886 | 2 169 |
| | | 0600 | | | | 14 | 630 | 600 | 1134 | 569 | 1,35 | 23,24 | 16,38 | 2 038 | 2 344 |
| | | 0900 | | | | 14 | 630 | 900 | 1638 | 822 | 1,35 | 33,46 | 23,10 | 2 710 | 3 117 |
| 11369 | 0720 | 0300 | XXXX | YYYY | -0000 | 16 | 720 | 300 | 688 | 349 | 1,33 | 14,88 | 11,04 | 1 972 | 2 268 |
| | | 0400 | | | | 16 | 720 | 400 | 896 | 450 | 1,35 | 18,88 | 13,60 | 2 074 | 2 385 |
| | | 0500 | | | | 16 | 720 | 500 | 1104 | 554 | 1,35 | 22,72 | 16,16 | 2 140 | 2 461 |
| | | 0600 | | | | 16 | 720 | 600 | 1296 | 650 | 1,35 | 26,56 | 18,72 | 2 314 | 2 661 |
| | | 0900 | | | | 16 | 720 | 900 | 1872 | 939 | 1,35 | 38,24 | 26,40 | 3 082 | 3 544 |
| 11369 | 0810 | 0300 | XXXX | YYYY | -0000 | 18 | 810 | 300 | 774 | 392 | 1,33 | 16,74 | 12,42 | 2 205 | 2 536 |
| | | 0400 | | | | 18 | 810 | 400 | 1008 | 506 | 1,35 | 21,24 | 15,30 | 2 320 | 2 668 |
| | | 0500 | | | | 18 | 810 | 500 | 1242 | 623 | 1,35 | 25,56 | 18,18 | 2 394 | 2 753 |
| | | 0600 | | | | 18 | 810 | 600 | 1458 | 732 | 1,35 | 29,88 | 21,06 | 2 590 | 2 979 |
| | | 0900 | | | | 18 | 810 | 900 | 2106 | 1057 | 1,35 | 43,02 | 29,70 | 3 454 | 3 972 |
| 11369 | 0900 | 0300 | XXXX | YYYY | -0000 | 20 | 900 | 300 | 860 | 436 | 1,33 | 18,60 | 13,80 | 2 438 | 2 804 |
| | | 0400 | | | | 20 | 900 | 400 | 1120 | 562 | 1,35 | 23,60 | 17,00 | 2 566 | 2 951 |
| | | 0500 | | | | 20 | 900 | 500 | 1380 | 692 | 1,35 | 28,40 | 20,20 | 2 648 | 3 045 |
| | | 0600 | | | | 20 | 900 | 600 | 1620 | 813 | 1,35 | 33,20 | 23,40 | 2 866 | 3 296 |
| | | 0900 | | | | 20 | 900 | 900 | 2340 | 1174 | 1,35 | 47,80 | 33,00 | 3 826 | 4 400 |
| 11369 | 0990 | 0300 | XXXX | YYYY | -0000 | 22 | 990 | 300 | 946 | 480 | 1,33 | 20,46 | 15,18 | 2 672 | 3 073 |
| | | 0400 | | | | 22 | 990 | 400 | 1232 | 618 | 1,35 | 25,96 | 18,70 | 2 812 | 3 234 |
| | | 0500 | | | | 22 | 990 | 500 | 1518 | 762 | 1,35 | 31,24 | 22,22 | 2 903 | 3 338 |
| | | 0600 | | | | 22 | 990 | 600 | 1782 | 894 | 1,35 | 36,52 | 25,74 | 3 142 | 3 613 |
| | | 0900 | | | | 22 | 990 | 900 | 2574 | 1292 | 1,35 | 52,58 | 36,30 | 4 198 | 4 828 |
| 11369 | 1080 | 0300 | XXXX | YYYY | -0000 | 24 | 1080 | 300 | 1032 | 523 | 1,33 | 22,32 | 16,56 | 2 967 | 3 412 |
| | | 0400 | | | | 24 | 1080 | 400 | 1344 | 674 | 1,35 | 28,32 | 20,40 | 3 120 | 3 588 |
| | | 0500 | | | | 24 | 1080 | 500 | 1656 | 831 | 1,35 | 34,08 | 24,24 | 3 219 | 3 702 |
| | | 0600 | | | | 24 | 1080 | 600 | 1944 | 975 | 1,35 | 39,84 | 28,08 | 3 480 | 4 002 |
| | | 0900 | | | | 24 | 1080 | 900 | 2808 | 1409 | 1,35 | 57,36 | 39,60 | 4 632 | 5 327 |

Zgodne z normą EN442-1: 2014:grzejniki i konwektory

POZIOMY (4-KOLUMNOWY)

JAK ZAMAWIAĆ GRZEJNIK RITMO POZIOMY

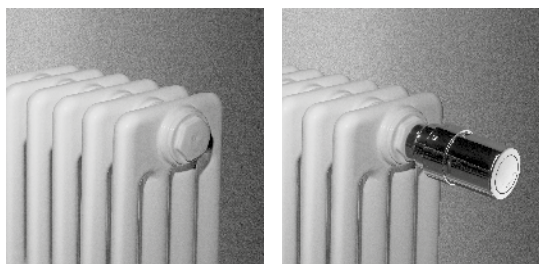

RITMO H-4K/145
(4-KOLUMNOWY)

RITMO H-4K/145
(4-KOLUMNOWY)
ZINTEGROWANY ZAWÓR

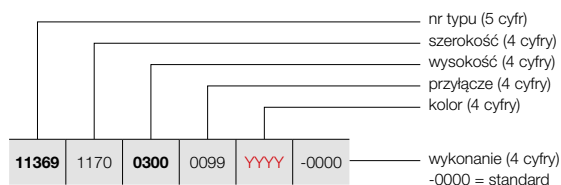

Wykaz zawiesi i konsol na str. 19 – 20

GRUPA PRODUKTÓW: KOLUMNOWE

| KOD PRODUKTU NA ZAMÓWIENIE RITMO POZIOMY | | | | | | | DANE TECHNICZNE | | | | | KOLOR STANDARD BIAŁY RAL 9016 | KOLORY | | | |
|--|------|------|------|------|-------|----|-----------------|----------------------|---------------------|-------------------------|-------------------------|----------------------------------|--------------|----------------|-------------------|-------------------|
| | | | | | | | Liczba rurek | Szerokość L mm | Wysokość H mm | 75/65/20 Wat φ50K | 55/45/20 Wat φ30K | Wykładnik n | Ciężar kg | Pojemność l | Cena netto PLN | Cena netto PLN |
| H-4K/145 : 11369 | | | | | | | | | | | | | | | | |
| 11369 | 1170 | 0300 | XXXX | YYYY | -0000 | 26 | 1170 | 300 | 1118 | 567 | 1,33 | 24,18 | 17,94 | 3 200 | 3 680 | |
| | | 0400 | | | | 26 | 1170 | 400 | 1456 | 731 | 1,35 | 30,68 | 22,10 | 3 366 | 3 871 | |
| | | 0500 | | | | 26 | 1170 | 500 | 1794 | 900 | 1,35 | 36,92 | 26,26 | 3 473 | 3 994 | |
| | | 0600 | | | | 26 | 1170 | 600 | 2106 | 1057 | 1,35 | 43,16 | 30,42 | 3 756 | 4 319 | |
| | | 0900 | | | | 26 | 1170 | 900 | 3042 | 1526 | 1,35 | 62,14 | 42,90 | 5 004 | 5 755 | |
| 11369 | 1260 | 0300 | XXXX | YYYY | -0000 | 28 | 1260 | 300 | 1204 | 610 | 1,33 | 26,04 | 19,32 | 3 433 | 3 948 | |
| | | 0400 | | | | 28 | 1260 | 400 | 1568 | 787 | 1,35 | 33,04 | 23,80 | 3 612 | 4 154 | |
| | | 0500 | | | | 28 | 1260 | 500 | 1932 | 969 | 1,35 | 39,76 | 28,28 | 3 727 | 4 286 | |
| | | 0600 | | | | 28 | 1260 | 600 | 2268 | 1138 | 1,35 | 46,48 | 32,76 | 4 032 | 4 637 | |
| | | 0900 | | | | 28 | 1260 | 900 | 3276 | 1644 | 1,35 | 66,92 | 46,20 | 5 376 | 6 182 | |
| 11369 | 1350 | 0300 | XXXX | YYYY | -0000 | 30 | 1350 | 300 | 1290 | 654 | 1,33 | 27,90 | 20,70 | 3 666 | 4 216 | |
| | | 0400 | | | | 30 | 1350 | 400 | 1680 | 843 | 1,35 | 35,40 | 25,50 | 3 858 | 4 437 | |
| | | 0500 | | | | 30 | 1350 | 500 | 2070 | 1039 | 1,35 | 42,60 | 30,30 | 3 981 | 4 578 | |
| | | 0600 | | | | 30 | 1350 | 600 | 2430 | 1219 | 1,35 | 49,80 | 35,10 | 4 308 | 4 954 | |
| | | 0900 | | | | 30 | 1350 | 900 | 3510 | 1761 | 1,35 | 71,70 | 49,50 | 5 748 | 6 610 | |
| 11369 | 1440 | 0300 | XXXX | YYYY | -0000 | 32 | 1440 | 300 | 1376 | 698 | 1,33 | 29,76 | 22,08 | 3 900 | 4 485 | |
| | | 0400 | | | | 32 | 1440 | 400 | 1792 | 899 | 1,35 | 37,76 | 27,20 | 4 104 | 4 720 | |
| | | 0500 | | | | 32 | 1440 | 500 | 2208 | 1108 | 1,35 | 45,44 | 32,32 | 4 236 | 4 871 | |
| | | 0600 | | | | 32 | 1440 | 600 | 2592 | 1301 | 1,35 | 53,12 | 37,44 | 4 584 | 5 272 | |
| | | 0900 | | | | 32 | 1440 | 900 | 3744 | 1879 | 1,35 | 76,48 | 52,80 | 6 120 | 7 038 | |
| 11369 | 1530 | 0300 | XXXX | YYYY | -0000 | 34 | 1530 | 300 | 1462 | 741 | 1,33 | 31,62 | 23,46 | 4 133 | 4 753 | |
| | | 0400 | | | | 34 | 1530 | 400 | 1904 | 955 | 1,35 | 40,12 | 28,90 | 4 350 | 5 003 | |
| | | 0500 | | | | 34 | 1530 | 500 | 2346 | 1177 | 1,35 | 48,28 | 34,34 | 4 490 | 5 164 | |
| | | 0600 | | | | 34 | 1530 | 600 | 2754 | 1382 | 1,35 | 56,44 | 39,78 | 4 860 | 5 589 | |
| | | 0900 | | | | 34 | 1530 | 900 | 3978 | 1996 | 1,35 | 81,26 | 56,10 | 6 492 | 7 466 | |
| 11369 | 1620 | 0300 | XXXX | YYYY | -0000 | 36 | 1620 | 300 | 1548 | 785 | 1,33 | 33,48 | 24,84 | 4 366 | 5 021 | |
| | | 0400 | | | | 36 | 1620 | 400 | 2016 | 1012 | 1,35 | 42,48 | 30,60 | 4 596 | 5 285 | |
| | | 0500 | | | | 36 | 1620 | 500 | 2484 | 1246 | 1,35 | 51,12 | 36,36 | 4 744 | 5 456 | |
| | | 0600 | | | | 36 | 1620 | 600 | 2916 | 1463 | 1,35 | 59,76 | 42,12 | 5 136 | 5 906 | |
| | | 0900 | | | | 36 | 1620 | 900 | 4212 | 2113 | 1,35 | 86,04 | 59,40 | 6 864 | 7 894 | |
| 11369 | 1710 | 0300 | XXXX | YYYY | -0000 | 38 | 1710 | 300 | 1634 | 828 | 1,33 | 35,34 | 26,22 | 4 599 | 5 289 | |
| | | 0400 | | | | 38 | 1710 | 400 | 2128 | 1068 | 1,35 | 44,84 | 32,30 | 4 842 | 5 568 | |
| | | 0500 | | | | 38 | 1710 | 500 | 2622 | 1316 | 1,35 | 53,96 | 38,38 | 4 998 | 5 748 | |
| | | 0600 | | | | 38 | 1710 | 600 | 3078 | 1544 | 1,35 | 63,08 | 44,46 | 5 412 | 6 224 | |
| | | 0900 | | | | 38 | 1710 | 900 | 4446 | 2231 | 1,35 | 90,82 | 62,70 | 7 236 | 8 321 | |
| 11369 | 1800 | 0300 | XXXX | YYYY | -0000 | 40 | 1800 | 300 | 1720 | 872 | 1,33 | 37,20 | 27,60 | 4 882 | 5 614 | |
| | | 0400 | | | | 40 | 1800 | 400 | 2240 | 1124 | 1,35 | 47,20 | 34,00 | 5 138 | 5 909 | |
| | | 0500 | | | | 40 | 1800 | 500 | 2760 | 1385 | 1,35 | 56,80 | 40,40 | 5 302 | 6 097 | |
| | | 0600 | | | | 40 | 1800 | 600 | 3240 | 1626 | 1,35 | 66,40 | 46,80 | 5 738 | 6 599 | |
| | | 0900 | | | | 40 | 1800 | 900 | 4680 | 2348 | 1,35 | 95,60 | 66,00 | 7 658 | 8 807 | |

Zgodne z normą EN442-1: 2014:grzejniki i konwektory

ZAWIESIA ŚCIENNE WRAZ Z KORKIEM I ODPOWIETRZNIKIEM DOSTARCZANE SĄ W KOMPLECIE Z GRZEJNIKIEM

- Konsle zaciskowe dodawane są w kolorze grzejnika.
- Uchwyty dystansowe dodawane są w korze w zależności od koloru grzejnika:
 - Białe RAL 9016 do grzejników w jasnych kolorach
 - Grafitowe RAL 7024 dla grzejników w ciemnych kolorach.

ZAWIESIA ŚCIENNE / KONSOLE PODŁOGOWE

OPCJONALNE



KONSOLA ZACISKOWA (nieregulowana) 30 mm



UCHWYT DYSTANSOWY

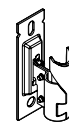

Odległość od ściany: 30 mm

| wysokość (H mm) | 2-kolumnowy / 3-kolumnowy / 4-kolumnowy | | |
|-------------------|---|---------|-------------|
| | 300 – 900 | | 1500 – 2200 |
| liczba rurek (n) | 10 – 28 | 30 – 40 | 6 – 16 |
| uchwyt dystansowy | 2x | 3x | 2x |

GRUPA PRODUKTÓW: ACC

| KONSOLA STOJĄCA | WYSOKOŚĆ KONSOLI | KOLOR | NUMER KATALOGOWY | PLN |
|---|----------------------|------------------|------------------|-----|
|  <p>KONSOLA STOJĄCA</p> <ul style="list-style-type: none"> Podłoga wykończona: wysokość konsoli = wysokość grzejnika kolumnowego + 150 mm Podłoga surowa: wysokość konsoli = wysokość grzejnika kolumnowego + 300 mm Konsle można skrócić zgodnie z potrzebą | RITMO POZIOMY | | | |
| | H = 450 mm | RAL 9016 | 118102000009016 | 177 |
| | | RAL 9005 | 118102000009005 | 232 |
| | H = 550 mm | RAL 9016 | 1181021000009016 | 177 |
| | | RAL 9005 | 1181021000009005 | 232 |
| | H = 600 mm | RAL 9016 | 1181022000009016 | 177 |
| | | RAL 9005 | 1181022000009005 | 232 |
| | H = 650 mm | RAL 9016 | 1181023000009016 | 177 |
| | | RAL 9005 | 1181023000009005 | 232 |
| | H = 750 mm | RAL 9016 | 1181024000009016 | 177 |
| | | RAL 9005 | 1181024000009005 | 232 |
| | H = 850 mm | RAL 9016 | 1181025000009016 | 217 |
| | | RAL 9005 | 1181025000009005 | 285 |
| | H = 900 mm | RAL 9016 | 1181026000009016 | 217 |
| | | RAL 9005 | 1181026000009005 | 285 |
| | H = 1050 mm | RAL 9016 | 1181027000009016 | 217 |
| | RAL 9005 | 1181027000009005 | 285 | |
| H = 1200 mm | RAL 9016 | 1181028000009016 | 217 | |
| | RAL 9005 | 1181028000009005 | 285 | |

ZESTAW NOŚNY DO KONSOLI STOJĄCEJ 60X10 mm



| RITMO POZIOMY | | | |
|----------------------|------------------|--|-----|
| RAL 9016 | 1181029000009016 | | 337 |
| RAL 9005 | 1181029000009005 | | 435 |

OSŁONA MASKUJĄCA KONSOLI PODŁOGOWEJ REGULOWANEJ – DO MONTAŻU NA PODŁODZE SUROWEJ

- 100 x 40 mm



| RITMO POZIOMY | | | |
|----------------------|------------------|--|----|
| RAL 9016 | 1181033000009016 | | 11 |

OSŁONA MASKUJĄCA DO KONSOLI WOLNISTOJĄCEJ – DO MONTAŻU NA GOTOWYM PODŁOŻU

- 115 x 110 mm



| RITMO POZIOMY | | | |
|----------------------|------------------|--|----|
| RAL 9016 | 1181034000009016 | | 21 |

Ceny netto PLN

| wysokość (H mm) | 2- / 3- / 4- kolumnowy | |
|------------------|------------------------|---------|
| | 300 – 900 | |
| liczba rurek (n) | 10 – 26 | 28 – 40 |
| ilość konsol | 2x | 3x |

GRUPA PRODUKTÓW: ACC

| KONSOLA PODŁOGOWA REGULOWANA H 200-230 mm | KOLOR | NUMER KATALOGOWY | PLN |
|--|----------|------------------|-----|
| | | | |
| <ul style="list-style-type: none"> Wysokość: min. 200 mm, max. 230 mm Teleskopowa konsola zalecana jest do montażu jako dodatkowe wzmocnienie grzejników pionowych w połączeniu z zawieszami ściennymi | RAL 9016 | 1181030000009016 | 194 |
| | RAL 9005 | 1181030000009005 | 254 |
| RITMO PIONOWY / RITMO POZIOMY | | | |
| OSŁONA MASKUJĄCA KONSOLI PODŁOGOWEJ REGULOWANEJ – DO MONTAŻU NA PODŁODZE SUROWEJ | RAL 9016 | 1181032000009016 | 11 |
| <ul style="list-style-type: none"> 70 x 40 mm | | | |
| RITMO PIONOWY / RITMO POZIOMY | | | |
| OSŁONA MASKUJĄCA DO KONSOLI PODŁOGOWEJ REGULOWANEJ – DO MONTAŻU NA GOTOWYM PODŁOŻU | RAL 9016 | 1181031000009016 | 21 |
| <ul style="list-style-type: none"> 130 x 110 mm | | | |

| wysokość (H mm) | 2-kolumnowy / 3-kolumnowy | | | | | 4-kolumnowy | | | | |
|------------------|---------------------------|---------|------------|---------|--------|-------------|---------|------------|---------|--------|
| | 300 – 600 | | 900 – 2000 | | 2200 | 300 – 600 | | 900 – 2000 | | 2200 |
| liczba rurek (n) | 10 – 24 | 26 – 40 | 6 – 24 | 26 – 40 | 6 – 16 | 10 – 24 | 26 – 40 | 6 – 24 | 26 – 40 | 6 – 16 |
| ilość konsol | 2x | 3x | 2x | 3x | 2x | 2x | 3x | 2x | 3x | 3x |

AKCESORIA OPCJONALNE

GRUPA PRODUKTÓW: ACC

| AKCESORIA | | KOLOR | NUMER KATALOGOWY | PLN |
|--|---|--------------------------------------|------------------|------------|
| GŁOWICA TERMOSTATYCZNA |  | RITMO PIONOWY / RITMO POZIOMY | | |
| | | BIAŁY | 11911630102 | 229 |
| | | CHROM | 11911631102 | 303 |
| ZAWÓR Z OSŁONKĄ PROSTĄ |  | RITMO PIONOWY | | |
| | | BIAŁY | 118200100009016 | 672 |
| | | INNE KOLORY | 11820010000xxxx | 771 |
| | | CHROM | 118200100000099 | 771 |
| | | W KOLORZE GRZEJNIKA | 11820010000xxxx | 771 |
| BŁOK PRZYŁĄCZENIOWY KĄTOWY 1/2" GZ / 3/4" GZ |  | RITMO POZIOMY | | |
| | | CHROM | 118230100000099 | 637 |

GRUPA PRODUKTÓW: LUXE ACC

| AKCESORIA | | KOLOR | NUMER KATALOGOWY | PLN |
|---------------------------------------|---|--------------------------------------|------------------|------------|
| PORĘCZ NA RĘCZNIKI CHROM – 1000 mm |  | RITMO PIONOWY / RITMO POZIOMY | | |
| | | CHROM | 118326500000099 | 602 |

- b = 1000 mm (poręcz można przyciąć zgodnie z potrzebą inwestora)

Ceny netto PLN

PRZYŁĄCZA

RITMO: PIONOWY

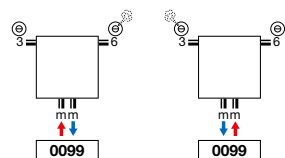

- Odpowietrznik w punkcie 3 lub 6.

RITMO: POZIOMY

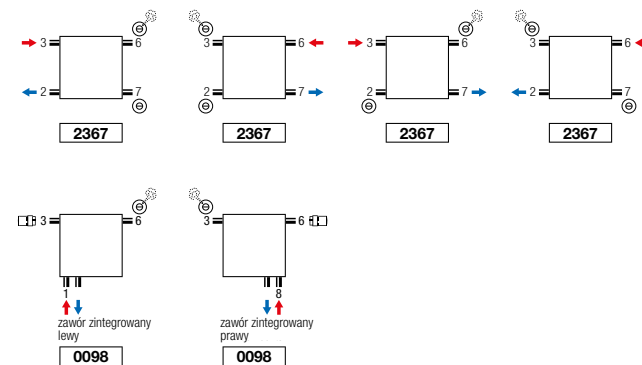

- Odpowietrznik w punkcie 3 lub 6.
- **PODŁĄCZENIE ZAWOROWE (0098) dopłata 378 zł**

RITMO PIONOWY

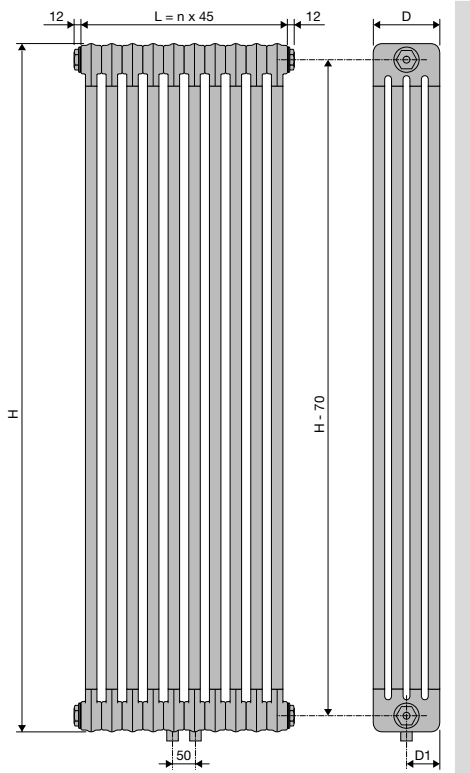

| V-2K/65 / V-3K/105 / V-4K/145 | | | | | | |
|-------------------------------|------|------|------|------|----|----|
| H | 1500 | 1800 | 2000 | 2200 | | |
| Głębokość (D) | 65 | 105 | 145 | | | |
| D1 | 32,5 | 52,5 | 72,5 | | | |
| Liczba rurek (n) | 6 | 8 | 10 | 12 | 14 | 16 |



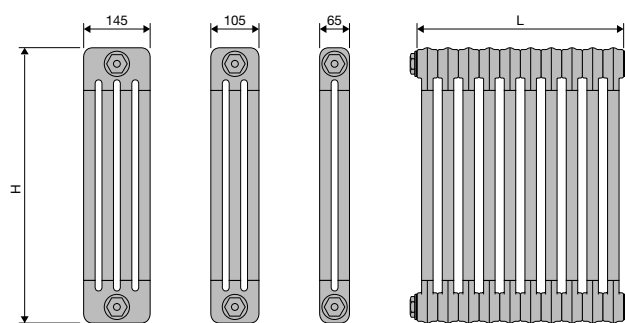
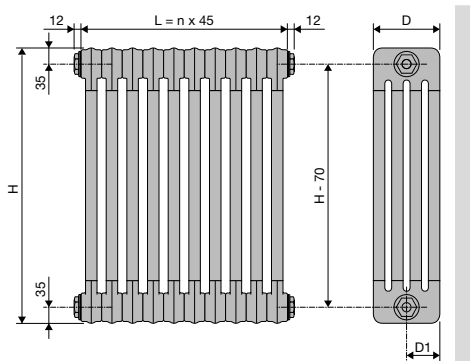
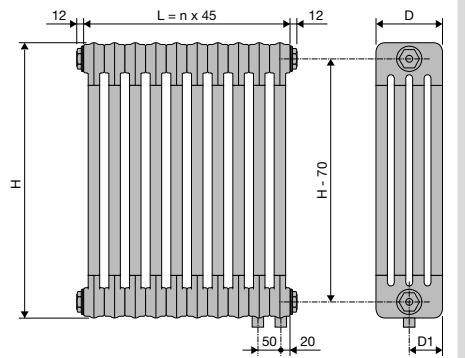
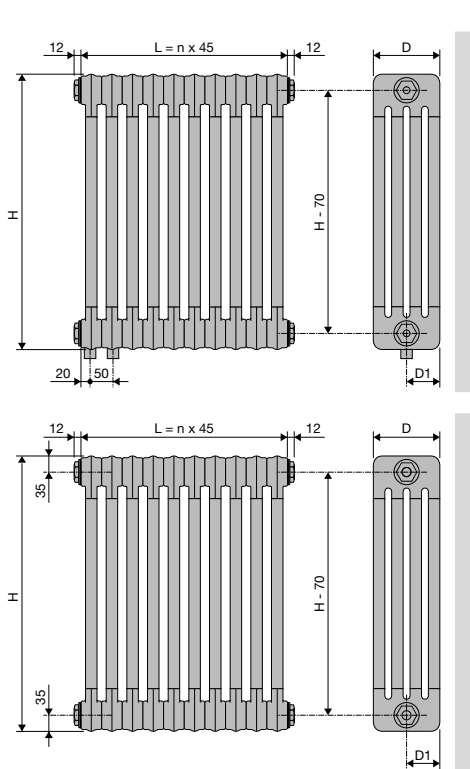

RITMO POZIOMY



H-2K/65 / H-3K/105 / H-4K/145

| | | | | | | | | | | | | | | | | | | | |
|------------------|------|------|------|-----|-----|----|----|----|----|----|----|----|----|----|----|----|--|--|--|
| H | 300 | 400 | 500 | 600 | 900 | | | | | | | | | | | | | | |
| Głębokość (D) | 65 | 105 | 145 | | | | | | | | | | | | | | | | |
| D1 | 32,5 | 52,5 | 72,5 | | | | | | | | | | | | | | | | |
| Liczba rurek (n) | 10 | 12 | 14 | 16 | 18 | 20 | 22 | 24 | 26 | 28 | 30 | 32 | 34 | 36 | 38 | 40 | | | |



| NOBLE | NEW | WHITE BLACK | NATURAL GREY MATT | PURE GREY MATT | METALLIC GREY STRUCTURE | BLUE GREEN MINERAL | TERRA COTTA MINERAL | UNI COLOURS FINE TEXTURE |
|---|--|---|---|--|---|--|---|-----------------------------|
|  |  |  |  |  |  |  |  | |
| Pergamon SAN 0019 | Cream White RAL 9001 | Sand Light N502 | Signal White RAL 9003 | Grey Aluminium M307 | Mid Blue 9802 | Dark Brown 9808 | Melon Yellow 9815 | |
|  |  |  |  |  |  |  |  | |
| Pink 3012 | Traffic White RAL 9016 | Sand N503 | Tele Grey 4 RAL 7047 | Aluminium Grey January M302 | Grey Blue 9803 | Quarts Brown 9810 | Carmine Red 9816 | |
|  |  | |  |  |  |  | | |
| Gold 9899 | Pure White RAL 9010 | | Window Grey RAL 7040 | Anthracite January M301 | Forest Green 9804 | Light Beige 9811 | | |
| |  | |  | | |  | | |
| | Jet Black RAL 9005 | | Tele Grey 2 RAL 7046 | | | Orange Brown 9812 | | |
| | | |  | | | | | |
| | | | Blue Grey RAL 7031 | | | | | |
| | | |  | | | | | |
| | | | Slate Grey RAL 7015 | | | | | |
| | | |  | | | | | |
| | | | Anthracite Grey RAL 7016 | | | | | |

KOLOR STANDARDOWY

Kolorem standardowym, dostępnym w podstawowej cenie jest **BIAŁY RAL 9016** z gładkim wykończeniem.

KOLORY

Grzejniki dekoracyjne malowane są farbą proszkową na wybrany kolor według palety.

Cena za grzejniki malowane w innych kolorach niż standardowy jest wyższa o 15%.

Firma VASCO zastrzega możliwość wprowadzania zmian w dostępności kolorów.
Ze względu na technikę druku zaprezentowane kolory mogą różnić się od rzeczywistych.



9990

Lakier proszkowy
bezbardwy



VASCO Group Sp. z o.o.
ul. Jaworzyńska 295
59-220 Legnica, PL
tel. +48 536 906 059
e-mail: sprzedaz@vasco.eu
www.vasco.eu

Kruishoefstraat 50
B-3650 Dilsen, BELGIA
tel. +32 89 79 04 11
e-mail: info@vasco.eu
www.vasco.eu

www.arbonia.com
Grupa Arbonia
ARBONIA